

An Investigation in to the Neural Structure of a  
Jellyfish

Mark Brooks

BSc in Computer Information Systems

2005

# **AN INVESTIGATION IN TO THE NEURAL STRUCTURE OF A JELLYFISH**

submitted by Mark Brooks

## **COPYRIGHT**

Attention is drawn to the fact that copyright of this thesis rests with its author. The Intellectual Property Rights of the products produced as part of the project belong to the University of Bath (see <http://www.bath.ac.uk/ordinances/#intelprop>).

This copy of the dissertation has been supplied on condition that anyone who consults it is understood to recognise that its copyright rests with its author and that no quotation from the dissertation and no information derived from it may be published without the prior written consent of the author.

## **Declaration**

This dissertation is submitted to the University of Bath in accordance with the requirements of the degree of Bachelor of Science in the Department of Computer Science. No portion of this work in this dissertation has been submitted in support of an application for any other degree or qualification of this or any other university of institution of learning. Except where specifically acknowledged, it is the work of the author. This thesis may be made available for consultation within the University Library and may be photocopied or lent to other libraries for the purpose of consultation.

Signed: .....

Mark Brooks / An Investigation in to the Neural Structure of a Jellyfish

## **Abstract**

Spiking neural networks are a relatively new concept that is based on biological neural systems. The concept has yet to be successfully applied to a living animal. The Jellyfish is the most primitive organism to possess a nervous system, so it would appear well suited for an initial investigation. This project examines various neuronal elements that are linked to the jellyfish swimming system and provides a good starting point for further investigation. Models have been built to replicate the swimming motor neurons, inner nerve ring and pacemaker. The findings have shown that current Spiking Neural Network software is capable of simulating general behaviour but falls short when it comes to complex modelling.

## **Acknowledgements**

I am grateful to many people who have helped me in writing this dissertation. Thanks go to my project supervisor Alwyn Barry for his encouragement, direction and advice; my parents for their patience, proof reading and constant support; William Megill for showing a real interest in the project and helping with the jellyfish details; Andrew Carnell for his help with CSIM; and the rest of my family and friends for offering a helping hand whenever it was needed.

# Contents

<b>1</b>	<b>Introduction</b>	<b>5</b>
1.1	Hypothesis . . . . .	6
1.2	Aims and Objectives . . . . .	6
1.3	Methodology . . . . .	7
1.4	Time Management . . . . .	8
<b>2</b>	<b>Literature Review</b>	<b>10</b>
2.1	Neural Networks . . . . .	10
2.1.1	Neural Network Concept . . . . .	10
2.1.2	History and Use . . . . .	11
2.1.3	Biological Neural Networks . . . . .	12
2.1.4	Spiking / Pulsing Neural Networks . . . . .	13
2.2	Jellyfish . . . . .	14
2.2.1	Evolution and Introduction . . . . .	14
2.2.2	Jellyfish Externals . . . . .	17
2.2.3	Subumbrellar Swimming Muscle . . . . .	17
2.2.4	Muscle Cells . . . . .	18
2.2.5	Jellyfish Internals . . . . .	19
2.2.6	Jellyfish Neural Structure . . . . .	20
2.2.7	Inner Nerve Ring . . . . .	20
2.2.8	Swimming Motor Neurons . . . . .	21
2.2.9	Outer Nerve Ring . . . . .	21
2.2.10	Relationship Between INR, ONR and SMNs . . . . .	23
2.3	Concluding Remarks . . . . .	23
<b>3</b>	<b>Requirements and Design</b>	<b>25</b>
3.1	The Project Focus . . . . .	25
3.2	How the Swimming System Works . . . . .	25
3.3	Why Focus on the Swimming System? . . . . .	27
3.4	The Neural System . . . . .	28
3.4.1	Neural Subsystems . . . . .	28
3.4.2	The Pacemaker . . . . .	30
3.4.3	The Inner Nerve Ring . . . . .	31
3.4.4	The Swimming Motor Neurons . . . . .	32
3.4.5	The Swimming Muscle . . . . .	35
3.4.6	Combined Model . . . . .	37
3.5	Requirements . . . . .	37

<b>4</b>	<b>Spiking Neural Network Software</b>	<b>40</b>
4.1	Introduction . . . . .	40
4.2	Spiking Neural Networking Packages . . . . .	40
4.3	CSIM . . . . .	41
4.3.1	Getting and Installing CSIM . . . . .	42
4.3.2	Basic Objects and their Parameters . . . . .	42
4.3.3	Input, Output and Recording . . . . .	43
4.3.4	Plotting the Graphs . . . . .	44
<b>5</b>	<b>Development</b>	<b>46</b>
5.1	Development Process . . . . .	46
5.2	Testing Process . . . . .	47
5.3	Explanation of Graphical Output and Terminology . . . . .	48
5.4	Model 1 - A Ring of Swimming Motor Neurons . . . . .	50
5.4.1	Modelled Behaviour . . . . .	50
5.4.2	Hypothesis . . . . .	50
5.4.3	Implementation of model . . . . .	51
5.4.4	Conclusion . . . . .	55
5.4.5	Future Work . . . . .	56
5.5	Model 2 - A Ring of Swimming Motor Neurons (Improved) . . . . .	57
5.5.1	Modelled Behaviour . . . . .	57
5.5.2	Hypothesis . . . . .	57
5.5.3	Implementation of model . . . . .	58
5.5.4	Conclusion . . . . .	61
5.5.5	Future Work . . . . .	63
5.6	Model 3 - A Pacemaker . . . . .	63
5.6.1	Modelled Behaviour . . . . .	63
5.6.2	Hypothesis . . . . .	64
5.6.3	Implementation of model . . . . .	64
5.6.4	Conclusion . . . . .	67
5.6.5	Future Work . . . . .	72
5.7	Model 4 - Inner Nerve Ring . . . . .	72
5.7.1	Modelled Behaviour . . . . .	72
5.7.2	Hypothesis . . . . .	72
5.7.3	Implementation of model . . . . .	73
5.7.4	Conclusion . . . . .	76
5.7.5	Future Work . . . . .	78
5.8	General Conclusions . . . . .	78
<b>6</b>	<b>Conclusion</b>	<b>81</b>
6.1	Hypothesis . . . . .	81
6.2	Insights Shown by Simulation . . . . .	82
6.3	CSIM . . . . .	82
6.4	Contributions to Field . . . . .	84
6.5	Further Work for Computer Scientists . . . . .	85
6.6	Personal Reflections . . . . .	86
<b>A</b>	<b>Glossary</b>	<b>92</b>
<b>B</b>	<b>Gantt Chart</b>	<b>94</b>

<b>C</b>	<b>CSIM</b>	<b>96</b>
C.1	Errors in csim-1.0.zip . . . . .	96
C.2	Running CSIM on the University of Bath Campus Network . . . . .	96
<b>D</b>	<b>The Code</b>	<b>98</b>
D.1	Model 1 - A ring of Swimming Motor Neurons . . . . .	98
D.2	Model 2 - A ring of Swimming Motor Neurons (Improved) . . . . .	101
D.3	Model 3 - A Pacemaker . . . . .	104
D.4	Model 4 - Inner Nerve Ring . . . . .	107

# Chapter 1

## Introduction

In 450 B.C. Alcmaeon, an early Greek physician, was the first to conclude that the brain was the central organ of sensation and thought (Public Broadcasting Service 2005). Throughout the last few centuries, biological research has collated considerable information about the brain, e.g. (Kandel, Schwartz & Jessell 1991) and yet much remains undiscovered. With the development of modern electronics and computers, it has been a natural step to try and replicate the thinking process. This has stimulated the study of neural networks.

Neural networks are, fundamentally, an information-processing paradigm that attempts to copy the way biological nervous systems, such as the brain, process information (Stergiou & Siganos 1996). Biological neural nets are fast, error tolerant and adaptable. Neural networks can be considered to be composed of two basic elements: synapses and neurons, which are based upon similar components within the nervous system of living organisms. The past sixty years has seen a progression of increasingly complex neuron models. The most recent model is called 'spiking' or 'pulsing' neurons, where importance is placed on the timing of the spikes. Details of the history and various models are reviewed in section 2.1.

It must be highlighted that the Spiking Neural Network concept will only prove useful in the biological field if it can be used to model a living system. Any such living organism could be chosen, but it would seem sensible to build the foundations with something simple.

Natschlager (1998) identifies that the human brain is composed of roughly ten billion neurons and is incredibly complicated. In comparison, the jellyfish neural structure is made up of roughly eight hundred neurons (a hundred in the inner nerve ring and seven hundred in the outer nerve ring) (Mackie & Meech 1995, p.2272). This would suggest the neuronal structure of a jellyfish is relatively simple in respect of the neural network field, and would provide a suitable subject for investigation.



The relatively simplicity of the jellyfish neural system has resulted in a wealth of literature. Lin, Gallin & Spencer (2001, p.65) state that there has been significant attention given to the organisation and histology of nervous systems in jellyfish. They highlight the long history of such studies by mentioning such authors as, Hertwig and Hertwig 1878; Mackie 1960, 1971; Mackie and Singla 1975; Singla 1978a, b; Spencer 1979; Grimmelikhuijzen and Spencer 1984.

Despite the previous research, neither spiking neural networks nor jellyfish biology is at a complete level of understanding. Spiking neural networks are a relatively new concept that is still being developed and the neurology of jellyfish is only understood at a macro level. The list of what is unknown about these two topics hugely exceeds what is known. According to the literature search, no researcher to date has combined the two fields to create a controller that mimics the behaviour of a jellyfish. The difficulty of representing an animal in a digital form is appreciated by the complexity and vast functionality of living creatures.

The appeal of the project is that it involves many different areas of science, and could be lead by a biologist or physicist as well as a computer scientist. The advantage of a computer science lead, however, is that it will more directly facilitate the complex computational calculations and relationships that will be needed to model even the simplest neurone structure of the jellyfish.

## 1.1 Hypothesis

The basics of jellyfish neurology are understood. It is also known that there exists software that models spiking neural networks. Therefore the hypothesis of the project is:

*Using available Spiking Neural Network Models a biologically plausible model of selected neurological behaviour of a jellyfish can be constructed.*

## 1.2 Aims and Objectives

The main aims of the project are as follows:

- To conduct a literature review and identify the key parts of the jellyfish nervous system
- To determine the current levels of understanding and design a preliminary jellyfish model
- To elicit software requirements for the model
- To investigate existing spiking neural network software

- To program a primitive model that displays some form of jellyfish behaviour

The main objectives required to complete the project are as follows:

- Research the following areas:
  - Neural Networks: The history and mechanics of the various models. Specialisation in spiking neural networks rather than continuous ones.
  - Jellyfish General: The behaviour (e.g. what inputs it gets from the environment), physiology (e.g. the composition and size) and mechanics (e.g. how it swims)
  - Jellyfish Neurology: The neural subsystems, connections between the subsystems, neuron types and a map of how the neurons are arranged
- Choose some appropriate parts of the jellyfish to model
- Design the model(s), highlighting literature references and assumptions made
- Implement the model(s) to provide the following features:
  - A variety of input values
  - Realistic behaviour
  - Meaningful output
- Perform a critical review of the research conducted and model(s) produced

### 1.3 Methodology

The project will require a Scientific Approach. Wolfs (2005) states:

“The scientific method is the process by which scientists, collectively and over time, endeavour to construct an accurate (that is, reliable, consistent and non-arbitrary) representation of the world.”

This statement clarifies the appropriateness of the Scientific Method for our project. We will endeavour to construct accurate representations of various neuronal elements within the jellyfish. The Scientific Method has four steps (Wolfs 2005), which can be applied to our project:

1. *Observation and description of a phenomenon or group of phenomena* - Although the project will not be concerned with observing jellyfish behaviour directly, it will require us to research from the existing literature. The research will hopefully result in a list of interesting phenomena.

2. *Formulation of a hypothesis to explain the phenomena* - From the interesting jellyfish behaviour that has been identified, a hypothesis of one of the mechanisms behind the behaviour will be made.
3. *Use of the hypothesis to predict the existence of other phenomena, or to predict quantitatively the results of new observations* - The jellyfish behaviour will be modelled with Spiking Neural Network software. This step will also require behavioural predictions of the model.
4. *Performance of experimental tests of the predictions by several independent experimenters and properly performed experiments* - The output from the models will be analysed and compared to the predictions that were made in step 3. Parts of the model that meet the hypothesis will be kept. Parts of the model that failed against the hypothesis will be modified. Although it is not possible for the project to perform independent experiments, it will form the starting point for such verifications.

Although the model has four steps it can be seen that iteration will be likely. If the hypothesis fails in step 4, it maybe appropriate to move back to step 3 and redesign the model. This will allow continual improvement of the model(s). Once the iteration has finished, the model will be analysed and the hypothesis will be either accepted or rejected.

The main advantage in using the Scientific Approach is that it minimises bias or prejudice from the experimenter. This is essential for a project that requires hypothesis testing.

## 1.4 Time Management

The scheduled time for this project is 300 hours over a 31-week period (11 October - 15 May). Therefore an average time of ten hours a week should be spent on the project. Jellyfish and neural networks are both broad topics, it is therefore important that time boundaries are set for different tasks of the project. The Gantt was produced to help with the management of the project and is shown in appendix B.

Some tasks have been divided into subtasks to make long periods of time more explicit. For example the four-week design task is split into three sub tasks:

- Get spiking neural network software working
- Learn software package
- Design programs

Parallel activities have been set where appropriate. Two design subtasks that have been planned to occur in parallel are: learning the software package; and

designing the programs. The reason for this is that they are complementary tasks and are likely to be worked on at the same time.

The write up will occur as part of every other task in the chart, and so will not be considered a separate task. Some additional time at the end of the project is allocated to collating the material.

There are several dependent tasks in the Gantt chart. These show tasks that need to be completed before others can be started. For example it would be unwise to start the Design task before a hypothesis was decided upon.

Periods of absence where no work will be completed are shown in the chart. Milestones are also identified when a significant point within the project has been reached. The effectiveness of the Gantt chart will be discussed in the conclusion.

## Chapter 2

# Literature Review

As might be expected, the review of the literature that follows shows the development of increasingly sophisticated models for neural networks from simple gates through to third generation pulse codes (which have the potential to accurately represent the real-life behaviour of jellyfish). The neural structure of a jellyfish is also examined. Specifically we highlight key areas of jellyfish neurology and physiology that are backed up by conclusive experimentation results.

### 2.1 Neural Networks

#### 2.1.1 Neural Network Concept

A neural network is an information-processing device. The terms ‘neural network’ and ‘artificial neural network’ are often used interchangeably. Artificial neural networks refer to the concept of replicating these neural networks through a computational model. The term neural network will be used as a general term within this literature review.

Neural networks process information. They receive input and filter it to produce relevant and meaningful output. Russell & Norvig (1994, p.567) define a network as a number of nodes (a simple processing unit), connected by links. Each unit has inputs (normally from other units), outputs (usually to other units) and an activation level. The activation level can be considered as a function that produces the output dependent on the input the node received. The links between the nodes have a weight property. The weight property determines how much of the signal is passed to the next node. If the all neurons are identical, the weighted links will determine the behaviour of the network.

Russell & Norvig (1994, pp.565-566) compare digital computers to neural networks. They comment that neural networks are more fault tolerant than com-

puters due to both redundancy and parallelism. They conclude “even though a computer is a million times faster in raw stitching speed, the brain ends up a million times faster at what it does”. A computer can only deal with a small amount of input in comparison to a neural network.

### 2.1.2 History and Use

The first neural network was developed by Alexander Bain in his 1873 book *Mind and Body. The Theories of Their Relation* (Olmsted 1998). Since then the field has seen some strange courses of development. Hennessy (2000) separates the history of neural computing into two time periods: 1940s-1970s and 1980s-present. Stergiou & Siganos (1996) identify the presence of the ten year gap as resulting from a book written by Minsky & Papert (1969), in which they summed up a general feeling of frustration (against neural networks) among researchers, and it was thus accepted by most without further analysis. This led to an elimination of funding and considerable prejudice against the neural network field. Ten years later, owing to the work of some independent researchers the interest in the field resumed.

Natschlager (1998) expands the identification of neural network history into three models:

- The First Generation - McCulloch & Pitts (1943) based their first neural model on a threshold gate where the neuron was treated as a binary device. The model had only a single layer (consisting of output nodes and weighted inputs). Although it was recognised as a powerful device, it was only capable of learning linearly separable patterns. It was considered unlikely that biological systems use such a binary encoding scheme.
- The Second Generation - This model was based on a sigmoidal gate. It encoded information in the firing rate (the number of spikes per second). Although in principle it could compute any analogue function, it has recently been criticised because of the waiting times to calculate an average. Maass & Bishop (2001, p.8) give the example of a fly. The fly is able to react to new stimuli and change flight direction within 30-40 ms. This is not a long enough time window to count spikes and average them. Therefore animals with quick reaction times could not be represented.
- The Third Generation - Results from experimental neurobiology gave rise to this new network model. It took into account the exact timing of individual spikes, which were thought to be more realistic to biological systems. In the above example of the fly, the use of this third generation model would enable it to react to single spikes. Natschlager (1998) states that this is very much the most advanced and realistic model of our time, though it does not preclude the use of the second generation model for appropriate tasks.

Smith (1996) describes some of the real life applications of neural networks. The potential variety and scope of where they can be applied is enormous. For example, Trading Markets are very volatile and attempts have been made to use neural networks to make predictions. British railway companies have been using neural networks to monitor their train engines. By monitoring noise levels and vibrations, early warnings of engine problems can be recognised.

### 2.1.3 Biological Neural Networks

If we are striving to reproduce the neural network of a living animal, we need to study how the biology and neural network paradigms relate.

The animal that interacts with its environment must be capable of receiving sensory input from the environment. It has to process this input, recognise the situation (for example, whether it has recognised a food source or a predator) and take the appropriate action.

Russell & Norvig (1994, p.564) give a thorough overview of neuron biology. They describe the neuron as the fundamental unit of all nervous system tissue. Each neuron consists of a cell body and a nucleus. This neuron gathers input from dendrites and distributes output via the axon. See figure 2.1.

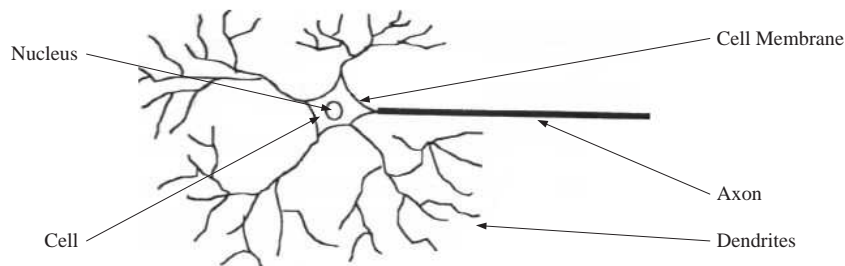

Figure 2.1: The basic components of a neuron. The cell maintains a voltage which is different to the exterior. The dendrites are the form of input. The axon is the form of output.

The dendrites are a bushy network around the cell and the axon stretches out a long distance. Figure 2.2 shows how two neurons interact.

A cell will receive input through the dendrites. Once this input has reached a certain potential, the cell will fire an electrical pulse down the axon. The pulse spreads out through the dendrites and the synapse converts the signal from one neuron to another through a complicated electrochemical reaction. Signals that

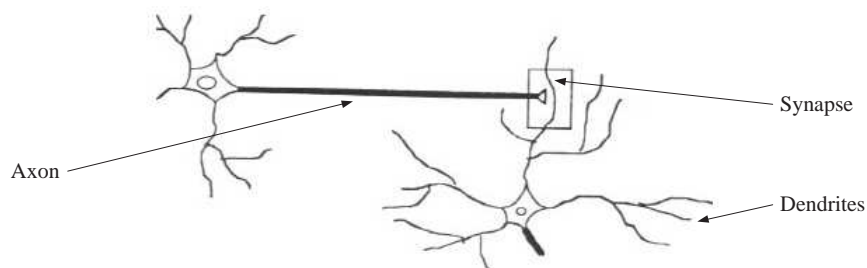

Figure 2.2: Two neurons. An electrical pulse is fired down the axon to a dendrite (in practice it will branch to many dendrites and cells). The synapse converts the pulse from the axon to the dendrite. The pulse spreads down the dendrites and changes the cell potential accordingly. The neuron on the left would be classified as presynaptic and the neuron on the right would be postsynaptic

lower the potential are called inhibitory, and those that increase it are called excitatory. Natschlager (1998) highlights the importance of the cell membrane (as shown in figure 2.1) to maintain a voltage difference between the level inside the cell and that outside it. It is common to refer to the sending neuron as the presynaptic neuron and the receiving neuron as the postsynaptic neuron.

Learning is a fundamental part of most neural networks. However, Carlson (1999) acknowledges the fact that the jellyfish has a (relatively!) simple design and its neural network is not cable of learning (we will therefore not study this aspect of neural networks any further). However, Russell & Norvig (1994, p.565) conclude that a collection of interconnected neuron cells can lead to thought, action and consciousness.

#### 2.1.4 Spiking / Pulsing Neural Networks

Maass & Bishop (2001, p.4) comment that typically, the duration of the entire action potential is in the range of 1-2 ms. It is also noted that in that all spikes within a given neuron are identical. Thus, the form of the action potential does not carry information. Rather, it is the number and the timing of spikes that matter. A chain of pulses emitted by a single neuron is known as a spike train.

Spiking neurons can be divided into two categories: pulse codes (taking the timing into account) and firing rates (taking the average number of spikes over a set time into account).



Maass & Bishop (2001, p.xiii) comment that the timing of spikes is well established as a means for coding information in electric fish. Although Maass & Bishop (2001, p.15) explain that it is often difficult to differentiate between the pulse code notion and firing rates, pulse coding seems to be most relevant to the jellyfish.

There are many types of pulse codes. Three codes from Maass & Bishop (2001, pp.11-15) are described below:

- Time-to-First-Spike (figure 2.3): A neuron abruptly receives a new input at time  $t_0$  (where the neuron is in theory turned on). The information is contained in the timing of the first spike to follow  $t_0$ . A neuron that fires shortly after  $t_0$  would indicate a strong stimulation and one that fires later would be a weaker stimulation.
- Phase (figure 2.4): The time-to-first spike is applied to a background oscillation. The spikes are relevant to the crest of the signal and will occur at every cycle.
- Correlations and Synchrony (figure 2.5): Spikes from other neurons could be used as a reference signal. For example, near simultaneous firing between a group of neurons could indicate a special event. A spatio-temporal pulse pattern could also be a meaningful event. For example, neuron  $n_1$  fires at time  $t$ , neuron  $n_2$  fires at time  $t + 5$  and neuron  $n_3$  fires at time  $t + 9$ .

To implement a jellyfish, a basic threshold spiking response model is described in Maass & Bishop (2001, pp.23-27). The relative simplicity of the model would make it a sensible choice for the initial modelling.

## 2.2 Jellyfish

### 2.2.1 Evolution and Introduction

Jellyfish have been drifting through the world's oceans for more than 650 million years (Kellan 1996) and their neural structure has been optimised over this time. Although their neural structures are relatively small and simple, they prove to be animals that are very efficient and effective in their environments. Megill (1991, p.27) comments that the *Polyorchis* uses two methods of swimming: active and passive. The active swimming is primarily used for swimming from one place to another, presumably in search of patches of abundant prey. The passive swimming is primarily used for an activity called sink-fishing, where the jellyfish maintains its position in the water column and uses gravity for movement. The active swimming will be of more interest in this project as it shows an easily measurable behaviour in terms of muscle contractions.

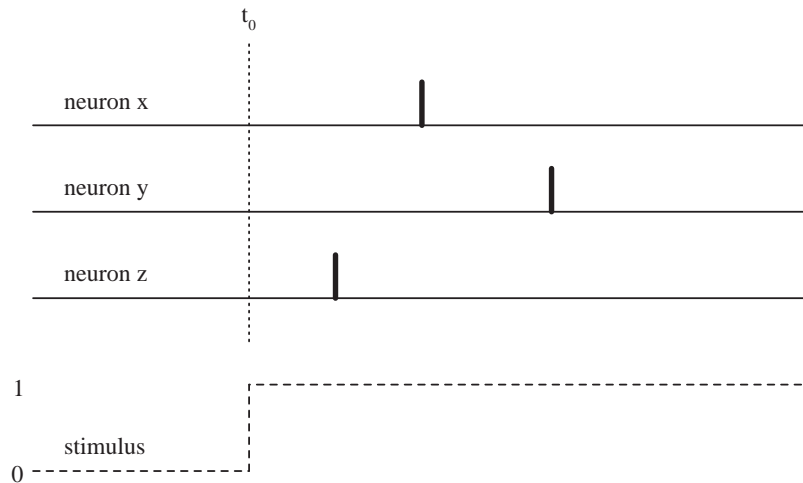

Figure 2.3: Time-to-first spike.  $t_0$  shows the when the stimulus is switched on. neuron z fires the shortest time after the stimulus is switched on, which can be interpreted as strong stimulation. Neuron y fires the longest time after the stimulus is switched on, which can be interpreted as weaker stimulation.

Jellyfish are classified in the phylum cnidaria. Cnidarians are incredibly diverse in form, ranging from corals to feathery hydroids. The classification of this group is based on the fact they all have nematocyst stinging cells. Satterlie (2002, p.1664) separates jellyfish into three distinct classes: Scyphozoa (covered-eyed medusae), Hydrozoa (naked eye medusae) and Cubozoa. Satterlie (2002, pp.1666-1667) highlights several commonalities between the classes, four of which are as follows:

- The use of a circular striated muscle for movement
- The use of neurons for conducting electrical activity
- The use of multiple, parallel conducting systems
- The use of chemical synapses

There is a wealth of information regarding the organisation of central nervous systems within bilaterally symmetrical animals such as a lobster. (Spencer & Arkett 1984, pp.69-70). Princeton Cognitive Science Laboratory (2005) define a bilaterally symmetrical animal as having identical parts on each side of an axis.

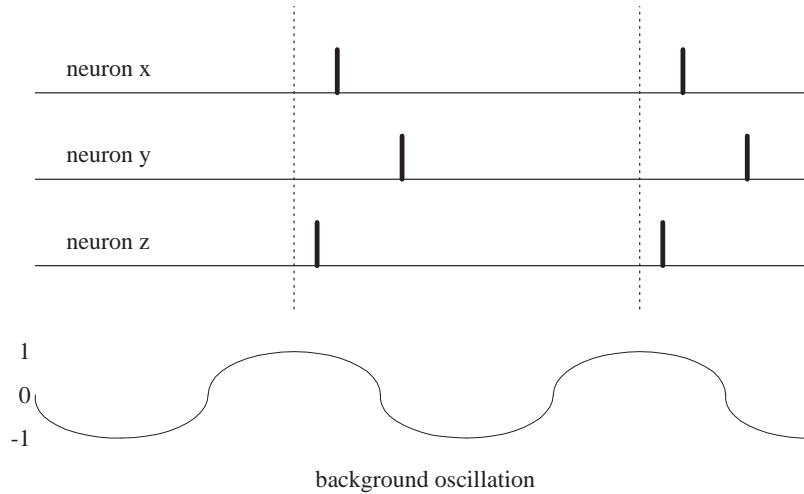

Figure 2.4: Phase. Neurons x, y and z fire on the same principle as time-to-first spike with respect to the crest of the background oscillation.

Spencer & Arkett (1984, pp.69-70) continue to say in contrast, little is known about the neural structure of radially symmetrical animals such as jellyfish. Princeton Cognitive Science Laboratory (2005) define a radially symmetrical animal as having a symmetrical arrangement of radiating parts about a central point.

Radially symmetric animals are very interesting. The sensory cells are equally distributed throughout the 360 degrees. If something were to excite the sensory cells equally through the whole 360 degrees, every part of the SMN network would be affected in the same way and this would elicit a general but undirected response. If, however, only a few sensory cells were excited locally, a specified local effect would be obtained.

This review will mainly concentrate on the Hydrozoan (specifically the *Polysiphonia penicillatus*, where possible) for three reasons. Firstly the hydrozoa displays an interesting, measurable behaviour (swimming) whereas the scyphozoa are passive drifters. Secondly, the hydrozoa is thought to be the most simplistic cnidaria. Lastly, and probably related to the second point, it is the hydrozoa that has been the focus of the vast majority of research.

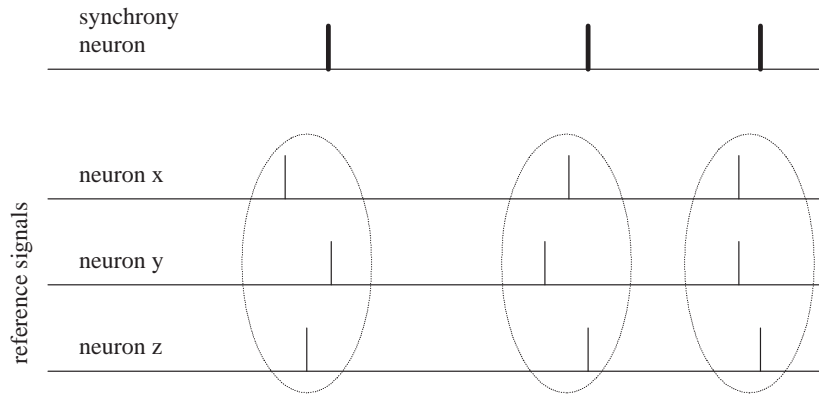

Figure 2.5: Synchrony. Spikes from neurons x, y and z are nearly synchronous, which results in the ‘synchrony neuron’ firing.

### 2.2.2 Jellyfish Externals

The jellyfish from an external point of view can be seen as a relatively simple animal. Figure 2.6 shows the basic structure of hydromedusae.

Hydrozoans swim by contracting circular musculature that lines the subumbrellar surface of the swimming bell (Satterlie 2002, pp.1654-1660). The muscle cells produce long duration, overshooting action potentials that spread through the subumbrellar. Some hydromedusae have nerve nets associated with the subumbrellar muscle. This is not the case with most hydrozoans (and not the case with polyorchis).

### 2.2.3 Subumbrellar Swimming Muscle

Spencer & Satterlie (1981, pp.403-404) experimented with thirty eight varieties of jellyfish and came to the following conclusion regarding the subumbrellar swimming muscle: there is a positive correlation between duration of the action potential in the muscle and the diameter of the bell opening.

They also discovered a directly proportional relationship between the duration of the swimming muscle action potential and the muscle contraction. It is the time to peak tension that varies, rather than the decay of tension. Therefore larger jellyfish tend to produce longer (i.e. slower) contractions than smaller

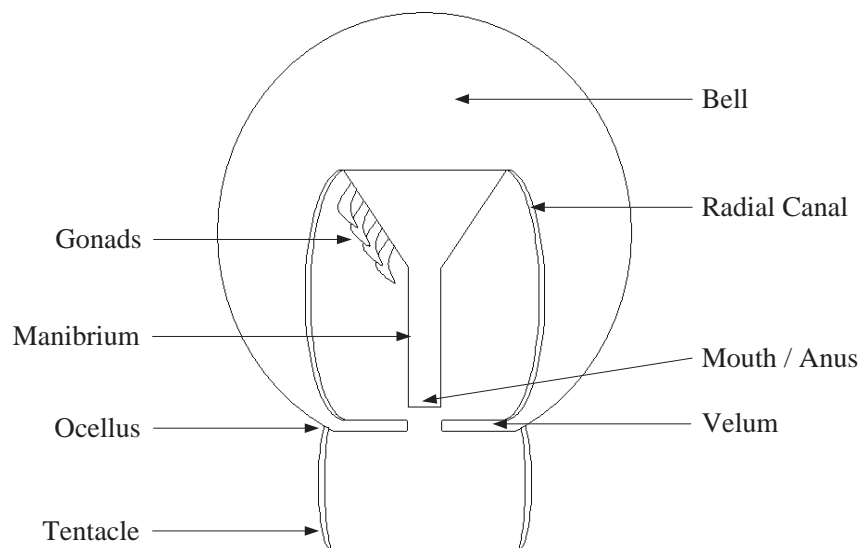

Figure 2.6: A cross section of a radially symmetrical Polyorchis penicillus

ones.

## 2.2.4 Muscle Cells

The first appearance of striated muscle during evolution was probably that of the medusae (Spencer & Satterlie 1981, p.401). Electrical recordings from the three muscular areas of the jellyfish (subumbrellar circular muscle, velar muscle and non muscular epithelium, shown in figure 2.7) all yield similar results (Satterlie & Spencer 1983). The results have been combined and can be seen in the table 2.1:

Bell Size Diameter (cm)	Muscle sheet recordings				
	Resting Potential (mV)	Action potential amplitude (mV)	Action potential duration (ms)	Muscle coupling	Synaptic potentials
0.5 - 4.0	-75	Up to 140	80 to 200	Yes	Yes

Table 2.1: Electrical activity recordings for the muscle sheets

Muscle action potentials have greater amplitudes and durations than neuron action potentials. Typically, the shape of muscle potentials is similar in all medusae (Satterlie & Spencer 1983, p.199). Characteristically, the muscle action potential has a rapid rise (this depolarisation is due to the sodium and calcium channels), clear plateau and rapid re-polarisation back to its resting potential. This gives the action potential a 'square' like appearance.

## 2.2.5 Jellyfish Internals

The neural structure of hydromedusae is fairly complex. A cross section of the bell margin (the location of the vast majority of nerves) is shown in figure 2.7.

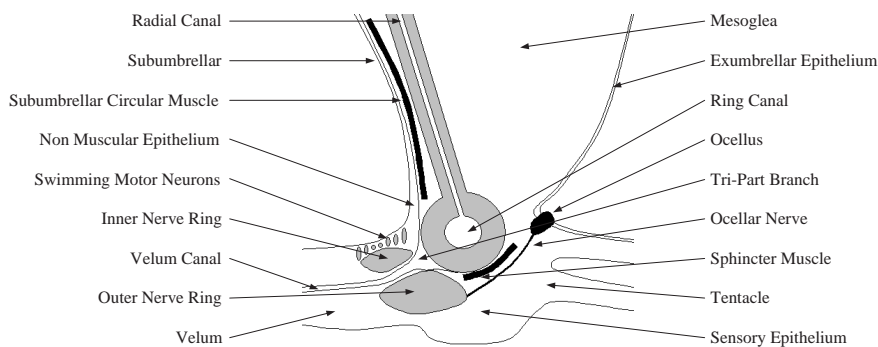

Figure 2.7: A cross section of the bell margin of a *Polyorchis penicillus*

Figure 2.7 shows some elements that are of particular interest. The Subumbrellar Circular Muscle enables the jellyfish to swim. The Swimming Motor Neurons initiate the muscle contraction. The Inner Nerve Ring combines several sub neural elements to initiate the SMNs. All these elements are discussed further in sections 2.2.3, 2.2.7 and 2.2.8.

Romanes (1885, cited by Satterlie & Spencer (1983, p.195)) pioneered some of the work that provides the foundation of our current knowledge. Satterlie comments on three particularly significant observations regarding the hydromedusae:

1. The excision of the entire bell margin (figure 2.7) causes a total, permanent paralysis of the entire organ.
2. If all but a small piece of the bell margin was removed, contractions of the subumbrellar muscle continued.

3. A cut through the bell margin noticeably slowed conduction of contraction waves past the cut.

From this we can conclude:

1. Swim pacemakers are probably only located in the bell margin.
2. The pacemakers are distributed throughout the 360 degrees of the margin.
3. A rapid conducting pathway in the margin controls the contractions of the subumbrellar muscle.

## 2.2.6 Jellyfish Neural Structure

Satterlie (2002, pp.1657-1659) indicates that the neural architecture of a hydrozoan can be categorised into two nerve rings: the subumbrellar inner nerve ring and the exumbrellar outer nerve ring. Both of these nerve rings are found at the junction of the swimming bell and the velum. The two nerve rings have a morphological division and are separated by mesogloea material. The mesogloea is shown in figure 2.7 and is the jellylike material that forms a significant part of the jellyfish. Neurites have been seen crossing this area and this is thought to be the way the two networks integrate (Spencer & Arkett 1984, pp.70-72)

## 2.2.7 Inner Nerve Ring

Electrophysiological evidence implies that the inner nerve ring controls the subumbrellar swimming muscle (Satterlie & Spencer 1983). The inner nerve ring has large neurons and a sparse, widespread network in comparison to the outer nerve ring (Satterlie 2002, p.1659). Satterlie (2002, p.1657-1659) identifies that the inner nerve ring is the most important element for swimming. He argues his point by emphasizing that overshooting action potentials always precede swimming contractions.

Mackie & Meech (1995, p.2272) estimate that there are roughly one hundred neurons in total in the inner nerve ring. Satterlie & Spencer (1983, p.197) summarise the electrical activity of these neurons for the *Polyorchis penicillatus* in table 2.2:

They go on to comment that during the morphological experimentation they discovered the polyorchis has roughly fifteen Swimming Motor Neurons (a relatively large number), measuring up to  $30\mu\text{m}$  in diameter (a relatively large size) in the inner nerve ring. Swimming Motor Neurons are discussed in the next section.

Bell Size Diameter (cm)	Inner nerve ring recordings			
	Resting Potential (mV)	Action potential amplitude (mV)	Action potential duration (ms)	Neuron coupling
0.5 - 4.0	-55 to -65	80 to 100	8 to 50	Yes

Table 2.2: Electrical activity recordings for the inner nerve ring

### 2.2.8 Swimming Motor Neurons

The swimming motor neurons (SMNs) are the epithelial cells that overlie the inner nerve ring of the hydrozoan. Their main function is to ensure the simultaneous contraction of the swimming muscle sheet. They are directly photosensitive due to a reflexive membrane within the cytoplasm (Spencer 1978, p.95).

Satterlie (2002, p.1659) observes that the swimming motor neurons have widespread electrical coupling and as a result there is normally a conduction delay. This conduction delay is compensated for by an appropriate synaptic delay. Thus, the combination of a conduction delay and a lesser synaptic delay results in a synchronous contraction of the subumbrellar muscle. This system is ideal for a radial jellyfish, the signal is received from a point on the circumference and will result in a signal sent around the jellyfish that is delayed to produce a balanced muscle contraction.

Spencer (1981, p.47) points out that SMNs generally produce unitary excitatory post-synaptic potentials. The SMNs directly form epithelial connections with the subumbrellar swimming muscle. It would therefore suggest that the muscle only contracts in one way. The SMN network has low-pass filtering that allows it to distinguish between sensory input that is general and local.

### 2.2.9 Outer Nerve Ring

The outer nerve ring is thought to be the pre-synaptic network to the inner nerve ring. Spencer & Arkett (1984) argue that the considerable amount of evidence has accumulated to suggest the outer nerve ring is primarily concerned with integrating sensory information. They identify two discrete networks within the outer nerve ring: the B (for Bursting) system and the O (for Oscillating) system. The two systems are identified by their physiological and morphological properties.



## **B System**

The B system consists of an electrically coupled network and plays a dual role in swimming.

It receives information from the ocelli (photo sensitive receptors). It then transfers this information to the SMNs (Spencer & Arkett 1984). Spencer & Arkett (1984) conducted an experiment with a shadow falling on the jellyfish and noted that there was a burst of spikes in the B system and a synaptic depolarisation of the SMNs. Previous authors' (Passano 1965, Mackie 1975, Spencer 1978, cited by Spencer & Arkett (1984, p.85)) have labelled the B as the 'pacemaker system'. The results from the experiments suggest that the burst of spikes could act as a switch to activate the pacemaker.

The B system also has a direct motor effect on the tentacles. The firing rate is directly correlated to the contractility of the tentacles (tentacle length). A high firing rate would result in the tentacles fully contracting, presumably to decrease drag (Spencer & Arkett 1984, p.74).

Spencer & Arkett (1984) tests with Lucifer yellow dye revealed a condensed network structure that has strong electrical coupling. They also indicate the system has a mean resting potential of -40 mV and action potentials with amplitudes of 75-80 mV and durations of 5 ms.

## **O System**

The O system is like the B system in that it is a network of electrically coupled neurons. Parts of the O system are found in the ocelli, suggesting that some sort of photoreception is involved in the system. The system does not produce spikes; rather it produces oscillations. In response to a shadow, the system stops oscillating. An increase in light results in a depolarisation of the network and increases the frequency and amplitude of the oscillations.

Spencer & Arkett (1984, p.82) believe that there is a strong connection between the O system and the SMNs and show many correlations between the two systems. The main correlation is between an increase in the O system oscillation frequency and the commencement of swimming. From this and the collated information on the B system, we could hypothesise that the O system forms the part of the pacemaker system that outputs regular action potentials.

Lucifer yellow dye revealed a branching network structure that extended up the sides of each tentacle towards the ocelli. Spencer & Arkett (1984, p.79) indicate that the system has a mean amplitude of 20 mV and the mean frequency of oscillation is 770 ms.

### 2.2.10 Relationship Between INR, ONR and SMNs

Figure 2.8 shows the interpretation of the relationships between the different neuronal attributes in the polyorchis penicillatus.

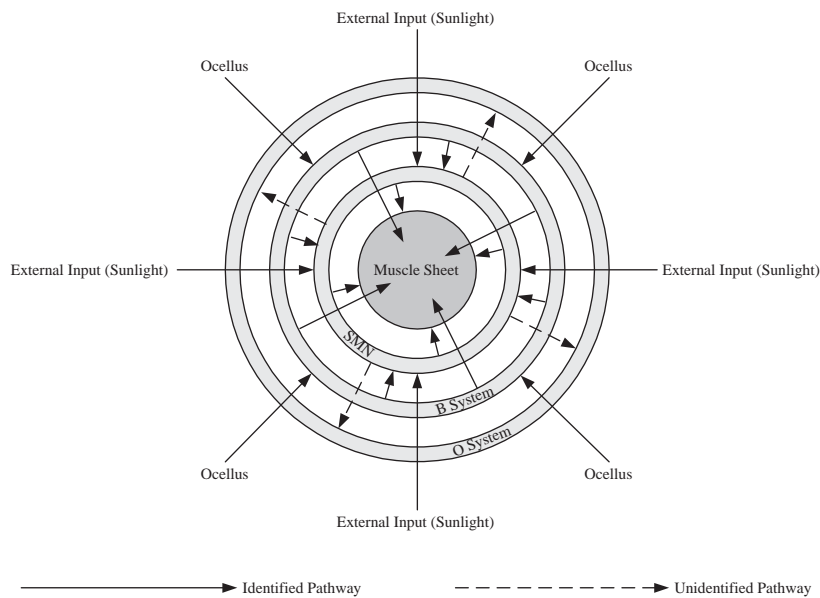

Figure 2.8: The physical relationship between the different neuronal attributes in the polyorchis penicillatus. The arrows represent pathways of connectivity. Adapted from Spencer and Arkett (1984)

## 2.3 Concluding Remarks

Although it may seem as though there is a large amount of information regarding the neural working of a jellyfish, this is a wrong assumption to make. We know relatively little about the sensory neurons within a jellyfish (Spencer & Arkett 1984, p.70). They comment that information regarding the physiologically and morphologically has yet to be identified. Anderson and Mackie (cited by Spencer & Arkett (1984)) address the pre-synaptic neurons as an area we know little about. The SMNs have yet to be morphologically characterised despite their presumed existence. Spencer & Arkett (1984, p.83) also remark that we are

still ignorant about the behaviour that involves local muscle contractions, for example turning and feeding.

Nonetheless, we can assume that the major mechanical requirement for a jellyfish is efficient jet propulsion (Spencer 1981). Efficient jet propulsion requires the swimming motor neurons to rapidly and symmetrically fire so that the muscle sheets contract and reduce the volume of the subumbrellar cavity. Jellyfish swimming is a measurable behaviour, and the mechanisms within the *Polyorchis* are well researched. It would therefore seem an appropriate lead for further investigation within this project.

## Chapter 3

# Requirements and Design

### 3.1 The Project Focus

The initial stage of this project was primarily literature-based research. The objective was to become familiar with two broad topics, namely jellyfish neural systems and the concept of spiking neural networks.

Due to the lack of experience in either of these areas, it was difficult to á priori focus on specific areas within these domains. The purpose of this chapter is to discuss the literature pertaining to the primary area of focus in more detail.

It was decided that the area of focus for this research should be the neuronal control of swimming in *Polyorchis Penicillatus*. Megill (1991) very much focused on the swimming system within this species but omitted the neuronal aspect. To make further progress in developing a model of the jellyfish swimming behaviour, more detailed research will be required on the neuronal swimming systems.

### 3.2 How the Swimming System Works

One of first significant findings was an anatomical picture of the *Polyorchis Penicillatus* (Lin et al. 2001). Satterlie (2002, p.1659) recognises figure 3.1 as the most complete anatomical picture of the nervous system of any cnidarian medusa to date and it will be a valuable resource through the rest of the project.

Megill (1991, p.ii and 12) and Satterlie (2002, p.1654) give a good overview of the mechanics behind the swimming of *Polyorchis Penicillatus*. The Jellyfish starts by contracting the circular muscle that lines the subumbrellar cavity. This serves to decrease the volume of water contained within this cavity and results in forward thrust through jet propulsion. The refilling of the cavity is powered

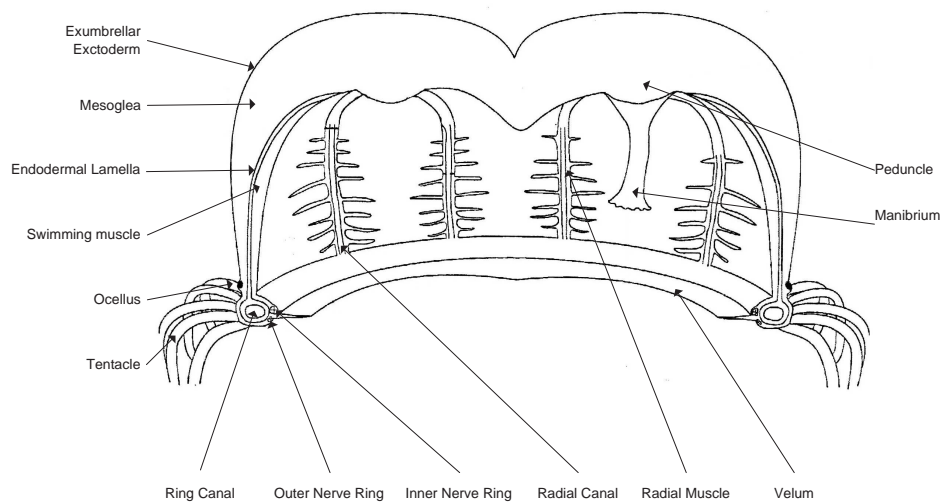

Figure 3.1: Diagram of the medusa of *Polyorchis Penicillatus*. Animal is cut open through the margin and bell. NOTE - The figure should not be confused with a cross section, the animal has been cut through the margin and one of the muscle sheets and then hinged open. The four radial canals can be seen along with the three intact muscle quadrants between them.

by strain energy stored in the deformation of the bell.

Megill (2005) comments on the way the muscle contracts from the apex down to the base. Lin et al. (2001, p.71) expands upon this by stating:

“muscle action potentials propagate inwards from the periphery through each triangular muscle sheet, a peristaltic pump is created since the narrower portion of the muscle sheet at the apex (within the SMN arch) is fully contracted before the wider region of the muscle sheet at the margin”

This can be simplified into four basic movements and is shown in figure 3.2.

The subumbrellar circular muscle is not actually a single muscle but four separate quadrants. Radial nerves lie between these quadrants (Lin et al. 2001, p. 66). When one of these muscle quadrants contract, the others do so in synchrony. This is necessary to produce a radial contraction that creates straight thrust.

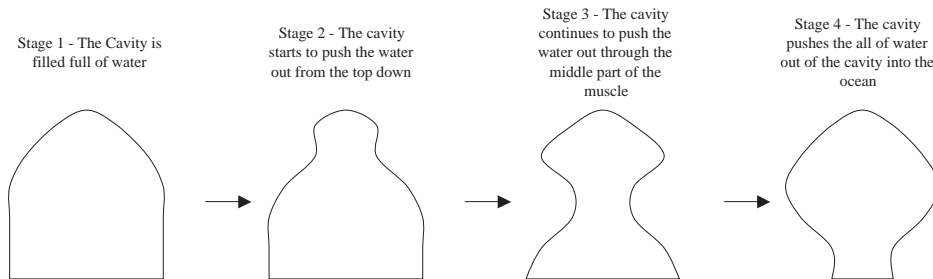

Figure 3.2: The four basic subumbrellar cavity movements that cause propulsion

Each muscle quadrant is actioned by *Swimming Motor Neurons* (SMNs). The action potential sent from the SMNs spreads through the muscle cells. The SMNs are electrically coupled to the *Inner Nerve Ring* (INR) (based at the bell margin) and also extend up either side of each radial canal to form a series of rings (Satterlie 2002, p. 1659). The INR is the main location of excitation to the SMNs. The INR has many stimulants including a pacemaker, direct stimulation from sensors and the *Outer Nerve Ring* (ONR).

### 3.3 Why Focus on the Swimming System?

There were many reasons for choosing the area of focus to be the swimming system of the *Polyorchis Penicillatus*. This section summarises those reasons.

The main interest of the project is how the subumbrellar muscle produces such a balanced contraction. Spencer (1981, p.46) comments that this is the major mechanical requirement for efficient jet-propulsion. Megill (1991, p.10) confirms that the muscle sheets are initiated simultaneously by the SMN ring at sites all around the periphery of the muscle sheet. The INR only stimulates one of the SMNs and the signal is sent around the ring and all the SMNs fire in synchrony. One would think that the neurons further around the ring would fire later than those earlier in the ring due to the delay of the synapses. Two mechanisms that are unknown and ripe for further research are: how the ring stops firing when the signal has been sent around once; and how each of the SMN rings fire in synchrony with one another.

Swimming is one of the main areas of interest within *Polyorchis Penicillatus*. As stated in the literature review, experts are still unsure of how jellyfish use local muscle contractions within the tentacles to turn and feed. Swimming is an easily measurable behaviour and considerable previous research has been carried out

on it, e.g. Megill (1991), Satterlie (2002), Satterlie & Spencer (1983), Spencer & Satterlie (1981).

The *Polyorchis* has been chosen as the main species of focus. This is because it has the largest amount of previous research conducted on it out of all the jellyfish species. This is probably due to the fact that the neural system can be interpreted more easily due to its relatively simplistic nature. Romanes (1885, cited by Satterlie (2002, p.1657)) compares the swimming systems of the Hydrozoan (naked-eyed Medusae) and the Scyphozoa (covered-eyed Medusae) and states that:

“... the nervous system in the naked-eyed Medusae is more highly organised, than in the covered-eyed Medusae” through a “gathering together of nerve-fibres into definite bundles or trunks”

The problem of gathering all the relevant information, interpreting this into a model and then getting a simulation running will be both interesting and challenging. There is no doubt that the project provides enough scope for an undergraduate project of this type. Any inroads to the modelling of this system will be significant because as far as the literature search can ascertain no researcher has tried to model such a system. It is very fortunate to have direct personal communication with William Megill, a researcher at the University of Bath and a leading authority in the field of jellyfish, and his knowledge will prove vital through the development of the project.

## 3.4 The Neural System

### 3.4.1 Neural Subsystems

There are many neural elements to *Polyorchis Penicillatus*. Not all of them relate to the swimming behaviour. Figure 3.3 shows a flow chart that has been gleaned from the literature to show the relevant swimming neural elements of the jellyfish and how they interact. Table 3.1 shows the references used to construct figure 3.3.

Figure 3.3 is particularly detailed and is probably the most complete swimming model created thus far. Previously mentioned elements in the literature review are all included in the model. The rectangular boxes represent neural subsystems. The B system and the O system are two identified parts of the ONR and should strictly be labelled as neural sub subsystems.

In the literature review it was hypothesised that the O and B systems combined to form the pacemaker. It was thought that the O system outputted regular action potentials and the B system operated as an activation switch. Further investigation found no explicit evidence that supported this hypothesis. There-

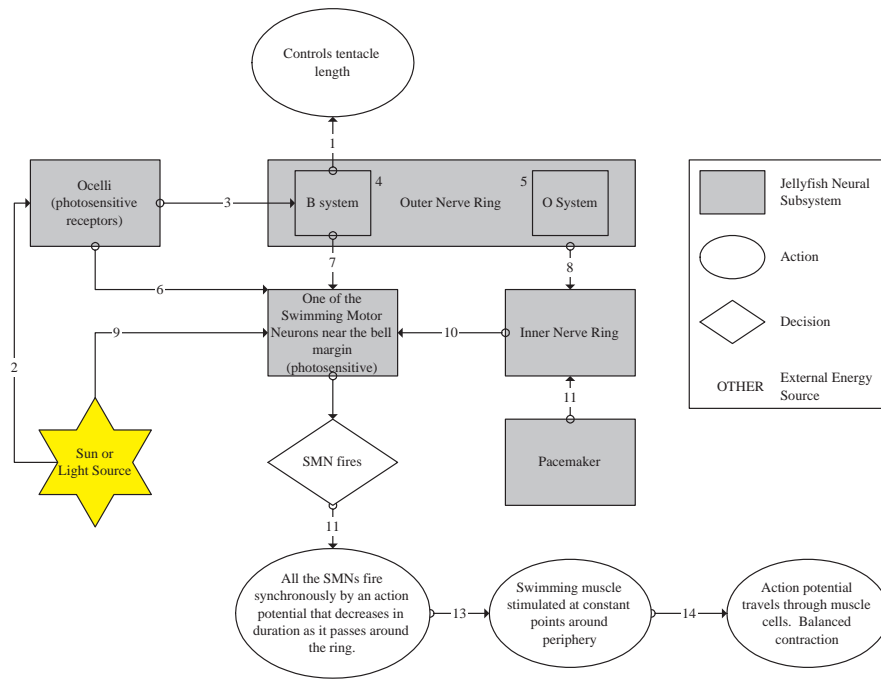

Figure 3.3: Theoretical Neural Pathways within the Polyorchis Penicillatus.

for the decision was taken to design and model the pacemaker as a separate unit.

From the substantial amount of literature reviewed it is possible to be optimistic figure 3.3 is a good initial model for the whole neural system. The network has high inter-connectivity and is fairly complicated. For example, the initial interpretation of the SMNs was that they were photosensitive and received stimulation from the INR. The diagram has the advantage of showing that they also receive direct stimulation from the ocelli and B system.

At the core of the swimming system there are particular elements that are of most interest to us. These elements are as follows: the *Inner Nerve Ring* (INR); the *Swimming Motor Neurons* (SMNs); and the Subumbrellar Swimming Muscle. These elements are described in further detail in the sections below. We will also investigate the pacemaker because of its close affiliation with the swimming system as a whole (the INR in particular) and its relative difference to most other neural elements.



<b>Pathway / Author / Quote</b>
1. - Spencer & Arkett (1984, p.85) - “the B system simultaneously controls tentacle length”
2. - Biology Daily (2005) - “Jellyfish also have ‘eyes’ or ocelli that cannot form images, but are sensitive to light”
3. - Spencer & Arkett (1984, p.85) - “the B system may receive its shadow-induced excitatory input from the ocelli”
4. - Spencer & Arkett (1984, p.85) - “The B system” “consists of a network of electrically coupled neurons in the outer nerve ring”
5. - Spencer & Arkett (1984, p.69) - “Two discrete networks of neurones in the outer nerve ring of <i>Polyorchis Penicillatus</i> ” can be recognised. “The O system is characterised by very regular spontaneous membrane potential oscillations”
6. - Spencer (1981, p.33) - “The SMNs . . . receive excitatory input from the ocelli.”
7. - Spencer (1981, p.33) - “The SMNs . . . receive excitatory input from that part of the system that controls tentacle length”
8. - Megill (2005) - “The Outer Nerve Ring feeds into the Inner Nerve Ring”
9. - Spencer (1981, p.33) - “The SMNs, which are directly photosensitive”
10. - Satterlie (2002, p.1659) - “Neurons of the ‘identified’ inner nerve ring form chemical synapses with overlying epithelial cells”. The epithelial cells being referred to are the SMNs.
11. - Satterlie & Spencer (1983, p.195) - “Pacemakers are distributed throughout the margin”
12. - Lin et al. (2001, p.71) - “Conduction delay is compensated by delays in motor spike duration which in turn modulates synaptic delay”
13. - Megill (1991, p.10) - “The muscle action potential is initiated simultaneously at all sites around the periphery of the muscle sheet by motor neurones running parallel to the radial canals”
14. - Megill (1991, p.10) - “The muscle action potential . . . travels across the sheet in myoid fashion”

Table 3.1: References for figure 3.3

### 3.4.2 The Pacemaker

The discussion begins with the function of the pacemaker for a good reason; of the four systems it is the first in the chain and it will go on to have an effect on the other three systems.

Spencer (1979, p.97) acknowledges the presence of pacemaker-like activity distributed throughout the INR and lists it as a general property of the neurons. The generation of these rhythmical action potentials is thought to come from the pacemaker system. Unfortunately there seems to be a lack of detailed information regarding this system. None of the papers reviewed have details of where the pacemaker receives its stimulation. It is doubtful there is any pre-synaptic network. A more likely explanation is that there would be stimulation from an

external energy source such as light or other stored energy.

The pacemaker system that sends rhythmical impulses to the INR can be compared to the cardiac pacemaker controlling the heart and we can hypothesise that it does it in a similar way. Wikipedia (2005*b*) describes the three main stages in the generation of an action potential in the pacemaker cells. Since the stages are analogous to contraction of cardiac muscle cells, they have the same naming system. This can lead to some confusion. There is no phase one or two, just phases zero, three and four.

- Phase 4 - The continuous outflow of the potassium ions causes the pacemaker cells to slowly depolarise as time goes on. The depolarisation continues until the threshold potential is reached and at this stage it enters phase 0.
- Phase 0 - The upstroke of the action potential occurs and calcium is let into the cells.
- Phase 3 - The repolarisation period starts due to the increase in potassium permeability and efflux of potassium (loss of positive ions).

Spencer & Satterlie (1981, p.406) reveal that the *Polyorchis* normally swims in bouts, with many muscle contractions occurring in each swimming bout. We could hypothesise that the pacemaker aids this type of swimming. The pacemaker would therefore need to be a system that produces regular action potentials that can be switched between on and off.

### 3.4.3 The Inner Nerve Ring

The *Inner Nerve Ring* (INR) forms a ring like structure at the bottom of the bell margin in the *Polyorchis*. The precise location can be seen in figure 3.1. Figure 3.3 shows that the pacemaker and outer nerve ring are pre-synaptic networks to the INR. The outer nerve ring is a complex system in itself and reviewing it further would be beyond the scope of this project.

The postsynaptic network to the INR is the swimming motor neuron network. There seems to be a lack of information regarding how these two networks connect. Spencer (1981, p.36) states that at each of the four per-radii (radial canals) there is partial thinning of the INR network. He believes this is where neurons connect with other neurons in the radial nerves. Because of the ambiguity of this statement, a simplification is made that the INR connects to each of the four SMN rings via a single synapse to just one of the SMNs.

Spencer (2005) notes that the INR contains other networks that are not directly associated with swimming. Megill (2005) backs this up describing the structure as bundles of networks. He illustrates the physical properties of the INR and they can be seen in figure 3.4. The figure shows several layers of neurons and

synapses presumably representing these different networks. In the literature review it was identified that there were 100 neurons in the INR. Spencer (1979, p.100) comments that there are as many as 500 axons connecting these neurons in the network.

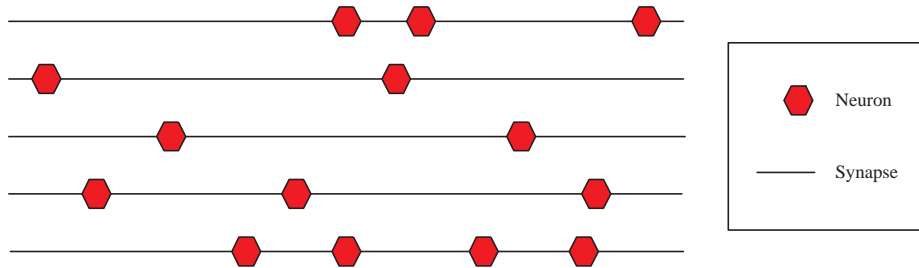

Figure 3.4: A cross section of the inner nerve ring taken from Megill (2005).

Since we are only modelling the swimming behaviour of the jellyfish, Megill (2005) has confirmed that modelling the INR as a single ring of neurons and synapses would be adequate at this stage. Satterlie & Spencer (1983, p.197) identify some electrical properties of the INR:

- Bell Size = 0.5 to 4.0 cm
- Resting potential = -55 to -65 mV
- Action potential amplitude = 80 to 100 mV
- Action potential duration = 8 to 50 ms

### 3.4.4 The Swimming Motor Neurons

The *Swimming Motor Neurons* (SMNs) form a continuous network located in both the inner nerve ring and up the four radial canals (Spencer 1979, 1981, cited by Spencer (1995, p.521)). The SMN network can be thought of as four neuron rings. Each ring surrounds one of the muscle quadrants by going up and down to one side of the radial canal and then along part of the inner nerve ring. Satterlie & Spencer (1983, p.199) state that the inner nerve ring contains approximately fifteen SMNs. No information source could be found that stated the number of SMNs located in the radial canals.

The SMNs initiate the contraction of the swimming muscle by sending an action potential through it. Spencer & Satterlie (1980, p.18) refer to the SMNs as motor giant neurons because they are a distinct class of comparatively oversized cells. Lucifer Yellow injected into the SMNs revealed that they are approximately 30  $\mu\text{m}$  in size (Satterlie & Spencer 1983, p.199).

Stimulation for the SMNs comes from many sources. From figure 3.3 we can see that pre-synaptic systems include the Inner Nerve Ring, the B system (part of the outer nerve ring) and the ocelli. As mentioned in the above section, it is unclear of how these systems connect to the SMN network. The SMNs also receive stimulation through direct photosensitivity.

Spencer (1982, p.360) identifies that the electrical coupling between cells in the swimming motor neuron network is very strong. The electrical coupling is known to have a speed advantage over chemically coupled neurons. Strong electrical coupling will result in a very quick network.

We have discussed the absolute need for a balanced muscle contraction. The preceding section shows that for this to occur all the SMNs need to fire at the same time. This is especially difficult because the SMNs are joined in a ring. Even with an electrically coupled network there is still some delay in transmitting the action potential from neuron to neuron. The overall effect will be that the first neuron will fire a significant time before the last neuron in the ring.

The SMNs offset this delay in a sophisticated way. Lin et al. (2001, p.71) explain that the delay for each SMN is compensated for by a change in motor spike duration. The SMNs fire when they start to enter the repolarisation stage so if all the SMNs have different spike durations it is possible to get them to fire in synchrony.

Spencer (1995, p.521) expands upon this by stating that:

“At its point of origin in the network the motor action potential has a long duration action potential (app. 25-40 ms).” . . . “As it propagates through the motor network the plateau becomes progressively lost so that at its furthest point of propagation it has the shortest duration (app. 7 ms).”

Therefore the length of the spike duration is directly proportional to the firing delay. The overall effect is that all the SMNs act as a single neuron and stimulate the muscle all around the periphery synchronously. The notion is explained in a graphical way in figure 3.5.

Spencer (1995, p.521) explains the mechanical basis of the decaying plateau duration. There are two membrane currents that are critical for the process: a fast, transient  $K^+$  current and a transient  $Ca^{++}$  current. The details of the process are beyond our requirements, although Spencer’s (1995) paper would be useful for further reading on this topic.

When one of the SMNs is stimulated all of the neurons only fire a single time. The signal does not continue around the ring to stimulate them a second time. No detail was available in the literature about how the jellyfish prevents this recurrent firing.

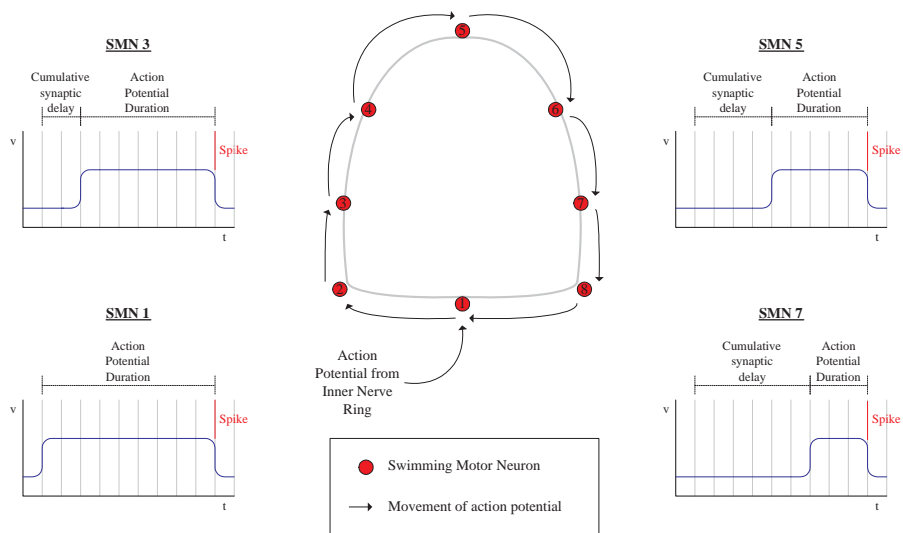

Figure 3.5: The SMN system - The reduction in action potential as the signal goes around the ring.  $v$  represents the voltage of the neuron.  $t$  represents the elapsed time.

It is understood how the neurons in a single SMN ring fire synchronously. What is not understood is how the four rings fire synchronously. For example, consider the following issues:

- A SMN in one of the rings is stimulated by its photosensitivity. There is no problem with the other neurons in that ring firing synchronously but how is the signal conveyed to the other three rings?
- A SMN is stimulated by the INR. The INR ring will take some time to pass the spiking action potential to the next ring. How do the three other SMN rings catch up with this delay?

Lin et al. (2001, p.71) discuss the SMN rings and state:

“Although it was suspected that this system formed a continuous network at the periphery of each subumbrellar muscle quadrant this study shows that continuity is maintained by the arches at the apex of each sheet, in addition to the continuous circular network in the inner nerve-ring”

This tells us that the four SMN rings joined by the INR are not actually independent as we first thought. Connectivity is also present at the top of the bell between all four rings. The connectivity of the system is made explicit, but how all the four rings fire in synchrony is not.

The question of how the four rings fire synchronously was referred to Megill (2005). It emerged that this was not an area that he was personally familiar with and, acting on his recommendation, the question was directed to Spencer (2005). The response from him indicated that the connectivity in the apex was an area that would bear further investigation as it is on the edge of current research understanding.

It has already been shown that all action potentials reach the SMN rings through junctions at the INR. It will also be assumed that these INR junctions delay the action potential to the SMN rings by a conduction compensation mechanism similar to that used in SMN delays to the muscle. Obviously these are two major simplifications, but it will hopefully allow the creation of the primitive model intended.

Experiments from Spencer (1981) identify some of the electrical properties of the SMNs.

- Membrane Resistance =  $98 \text{ k}\Omega \text{ cm}^2$
- Membrane Capacitance =  $1.52 \text{ }\mu\text{F cm}^{-2}$
- Duration of Action Potential = 4 to 40 ms
- Conduction Velocity = 112 cm per sec
- Resting Potential = -57 mV

Spencer (1995, p.521) states that the firing frequency varies with some extensive rest periods but it is generally around 1Hz.

- Firing Frequency  $\approx 1\text{Hz}$

### 3.4.5 The Swimming Muscle

Gladfelter (1972, cited by Megill (1991, p.11)) describes the subumbrellar muscle sheet of *Polyorchis* as divided into four quadrants, separated by the radial canals. The muscle is stimulated by the four SMN rings discussed earlier.

Spencer's (1982) paper describes the way the SMNs stimulate the muscle sheets. The SMNs do not synapse directly on to the muscle; between them are overlying epithelial cells. These epithelial cells are arranged in lateral margins (the

horizontal canals running through the radial muscle shown in figure 3.1). (Lin et al. 2001, p.67).

Megill (1991, p.10) describes the way the action potential spreads from the periphery of the muscle to the middle. He illustrates this with a diagram of the muscle that can be seen in figure 3.6.

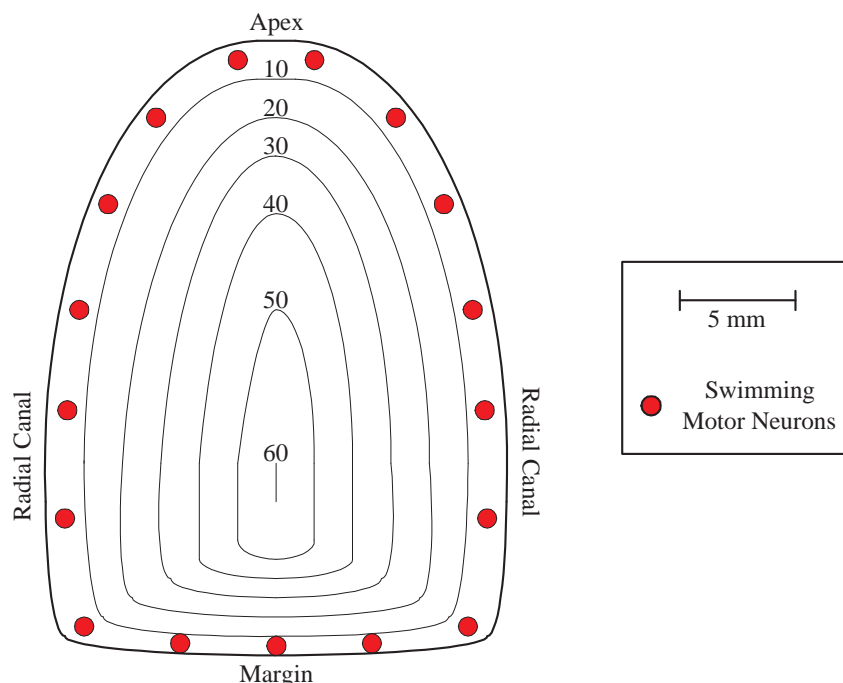

Figure 3.6: Contraction timing of Polyorchis swimming muscle contraction. Redrawn from Megill (1991, p.10).

The action potential in figure 3.6 travels quicker circumferentially around the jellyfish (horizontally on the diagram) than it does longitudinally. The result is an apex to margin muscle contraction that produces propulsion (figure 3.2).

Spencer & Satterlie (1981, p.404) note that the *duration* of the action potential is directly proportional to the size of the Polyorchis jellyfish. The understanding behind this is that a longer contraction is needed for a larger volume pump. They conclude that the muscle must carry information about the required duration of the contraction and that this changes as the jellyfish grows. They also state that

there is no significant correlation between the size of jellyfish and the *amplitude* of the swimming muscle potentials.

### 3.4.6 Combined Model

What follows is a physical model of how the main neural subsystems (INR, SMNs and the Subumbrellar Swimming Muscle) connect. To make the model easy to interpret, some neural aspects have been omitted: the INR having direct stimulation from the ONR and a group of sensors; the SMNs being photosensitive and having direct stimulation from another group of sensors.

Figure 3.7 shows this model. The INR is composed of a ring of neurons. One can see that the INR stimulates one SMN from each of the rings. The SMNs are all connected electrically. Finally, the SMNs connect to the muscle via epithelial cells.

It is recognised that the model is not a complete representation of a real jellyfish. For example, it is very unlikely that the INR connects to each of the SMN rings with a single synapse; and no account has been taken of the SMNs connecting at the apex. However, the objectives set out at the beginning of this project emphasised the production of an initial primitive model. This model succeeds in meeting this objective.

## 3.5 Requirements

This section can be considered an overview of what has already been discussed in this chapter. It summarises the features of the *Polyorchis Penicillatus* swimming system. These will act as benchmarks of how realistic the artificial model is.

A research project of this scope often means that the requirements gathering is a difficult process. However it was decided that such an important stage of the development process could not be left out entirely. The importance of defining the design criteria in a concise reference list will be extremely important in managing expectations and developing the artificial models.

The requirements gathering process was not implemented in the normal way as it would be for a development project because it is difficult to draw up specific requirements for such an experimental project. However, this did not mean that the principles from such methods could not be used.

As a consequence, the material discussed in the preceding sections of this chapter should be viewed as a problem description in which requirements were extracted in a sequential and methodical order. The requirements can be viewed as being rather fluid. This will have the beneficial effect of allowing them to be specified in more detail as the development process advances. To ensure the project has



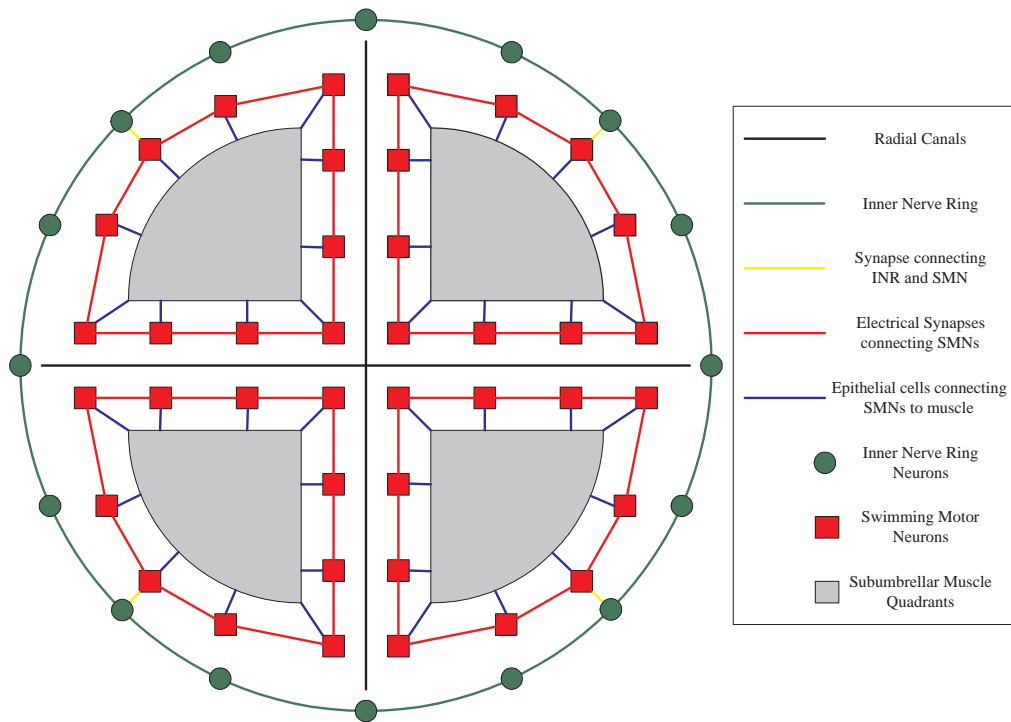

Figure 3.7: Physical Neural Mapping

as firm a foundation in fact as possible, the information has been validated through regular citations of reliable information sources.

The functional requirements are grouped by the sub neural elements identified.

1. The Pacemaker Model

- (a) Design Aspects (Where hypotheses have been made)

- i. Should take in one input to represent stimulation from an external source

- (b) Behaviour Principles

- i. Must generate a regular output of action potentials
    - ii. Should generate a realistic number of action potentials per second

- iii. Should be able to be switched off when generating output
  - (c) Other Properties
    - i. Should have similar physical properties to the biological pacemaker where possible
    - ii. Should have similar electrical properties to the biological pacemaker
- 2. The Inner Nerve Ring
  - (a) Design Aspects (Where hypothesises have been made)
    - i. Should take all input through a single neuron
    - ii. Must have four output neurons that connect to the SMN rings
    - iii. Must offset the stimulation so that all SMN rings are initiated simultaneously
  - (b) Behaviour Principles
    - i. Must take input from two sources (pacemaker and ONR)
    - ii. Must form a ring of neurons that stops spiking when it has initiated the SMNs
    - iii. Must only spike after sufficient stimulus
  - (c) Physical Properties
    - i. Should have similar physical properties to the biological INR where possible
    - ii. Should have similar electrical properties to the biological INR
- 3. The Swimming Motor Neurons
  - (a) Design Aspects (Where hypothesises have been made)
    - i. Should take all input through a single SMN
    - ii. Should not be required to take in complex input (i.e. Photosensitivity, B system and sensors)
    - iii. Should have no connectivity at the apex of the SMN rings
  - (b) Behaviour Principles
    - i. Must take in the relevant input (i.e. INR)
    - ii. Must all fire in synchrony
    - iii. Should fire at a similar rate to that of the muscle(i.e. 1 Hz)
  - (c) Physical Properties
    - i. Should have similar physical properties to the biological SMNs where possible
    - ii. Should have similar electrical properties to the biological SMNs

Non-functionally the simulator should run on the University of Bath network. The Gantt chart shows that the programming should be completed by Mid April to allow for sufficient analysis.

## Chapter 4

# Spiking Neural Network Software

### 4.1 Introduction

As identified in the requirements, the jellyfish neuronal model needs to be based on a *spiking neural network (SNN)* (also known as pulsing neural networks (PNN)). There are two options for the software we may use:

1. Write a new simulator. Maass & Bishop (2001) identify several models that might be suitable for us to program.
2. Attempt to integrate and use an existing software package.

Previous undergraduate projects at the University of Bath have attempted the first option e.g. O'Dwyer (2004). These projects were solely based on the investigation of neural networks and had no other associated fields (such as Jellyfish). It would therefore seem that writing software to simulate an SNN would be a challenging project in itself. Due to time constraints and objectives of this project, a decision was taken that if a suitable existing software package could be found for this type of project, it would be used.

### 4.2 Spiking Neural Networking Packages

A modest study was conducted into the following SNN packages:

- Amygdala (<http://amygdala.sourceforge.net/>)- Provides realistic modelling for biological systems. It also offers physical representation of SNN

activity. Unfortunately there seems to be limited manipulation of the synapses. The software is very much in its early stages of development but looks to be progressing fairly quickly.

- CSIM (<http://www.lsm.tugraz.at/csim/>) - Allows different models and detailed manipulation of both the neurons and synapses. Simple and clear graphical output through Matlab
- Genesis (<http://www.genesis-sim.org/GENESIS/>) - Object orientated design. Unfortunately Genesis only allows simulation of neural networks, not SNNs.
- Neuron (<http://www.neuron.yale.edu/>) - Object orientated design. This simulating software developed by Yale again only offers support for neural networks, not SNNs.
- Spiking Neural Simulator (<http://www.cs.stir.ac.uk/~lss/spikes/snn/>) - Leslie Smith has produced a fairly simple package. It offers an easy to use graphical interface and runs under MacOSX. There seems to be a limitation with the manipulation of the synapses and neurons.

As the list shows, there are a limited number of options for appropriate software. Commercial software was not investigated as there was no budget for this project.

Two postgraduate students who study SNNs at the University of Bath (Andrew Carnell and Carl O'Dwyer) were consulted. Knowing the project background, they favoured the CSIM package. Carnell had used the software in the past and offered to assist with any problems or issues. Many of the other packages focus on either neurons or synapses, whereas CSIM seems to allow one to change the parameters for both of these elements. CSIM is also distributed freely under the GNU General Public Licence.

The review for the available software was intentionally brief and concise. The choice of a correct package was key to a successful outcome and the advice of the experienced postgraduates was a major factor in taking the decision to use CSIM. The additional points in the above paragraph also support the decision.

### 4.3 CSIM

CSIM (Circuit *SI*Mulator) is written by the IGI LSM Group at the Graz University of Technology, Austria. The homepage for the software can be found at the following url:

<http://www.lsm.tugraz.at/csim/index.html>

There is an well written and comprehensive manual (IGI 2004) from which information has been gathered and is discussed intermittently through the rest of this chapter.

CSIM is free software that can be redistributed and/or modified under the terms of the GNU General Public Licence. The software can run on both Windows and Unix (Linux).

The software is capable of simulating networks composed of heterogeneous neurons and synapses. The simulator is written in C++ and has a MEX interface to Matlab. It can simulate networks containing up to ten thousand neurons and a few million synapses (the actual size is dependent on the amount of RAM available on the running machine)

There are several modelling options included with CSIM. There are different neuron models including leaky-integrate-and-fire neurons, compartmental based neurons and sigmoidal neurons. There are also many different synapse models including static synapses (weights only change through learning) and dynamic synapses (weights can change with network activity). See Maass & Bishop (2001, p.321) for further details.

CSIM provides an easy to use Matlab interface and it is therefore not necessary to learn any other script language to set up simulations. Results from the simulation are returned as simple Matlab array structures and they can therefore be displayed with the wide range of analysis tools that Matlab has to offer.

The software is designed in an object orientated fashion. C++ is used as the simulation tool that does all the core processing of the data, but is relatively difficult to program. Fortunately the interface to the package is via Matlab scripts which are used to create objects, connect objects and set parameters. Matlab provides a fast and productive programming environment.

### 4.3.1 Getting and Installing CSIM

The instructions for installing CSIM can be found at the following URL:

`http://www.lsm.tugraz.at/download/index.html`

It was a difficult process to get the software up and running, and details can be found in appendix C.

### 4.3.2 Basic Objects and their Parameters

The three basic elements needed for a spiking neural network in CSIM are a *leaky-integrate-and-fire* (LIF) neuron; a static spiking synapse; and an input

spike train. These elements will suffice for the initial modelling but more advanced elements may be used as the model is developed further. A basic model of how the elements fit together is shown in figure 4.1. The connections between the elements in the program script have to be defined to program the model.

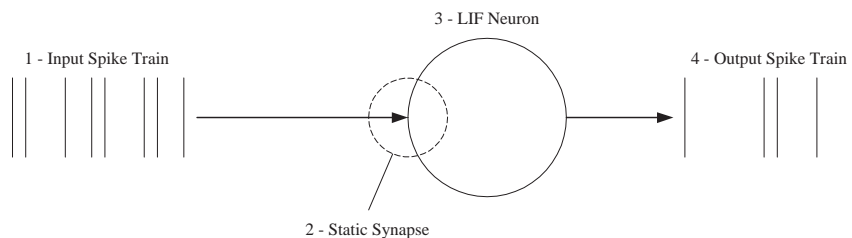

Figure 4.1: A model of how the basic CSIM elements (adapted from IGI (2004))

Figure 4.1 shows what is apparently four elements: the input spike train (1) transmitting a signal to the synapse (2), which channels the information to the neuron (3), which outputs a spike train (4). The output spike train is not an object that is explicitly created. The output spike train is dependent on the other three elements and is the part computed by CSIM.

One can change the parameters of the neurons and synapses to make them act differently within the network. Tables 4.1 and 4.2 summarise the parameters for the LIF neuron and static synapse respectively. They also state the units of measurement and whether the parameters are modifiable (read and write) or internal state variables (read-only).

### 4.3.3 Input, Output and Recording

The input and output spike trains can be thought of as an array of timings. The spikes do not vary in size/amplitude and all information is carried in their timing. The obvious difference between the two spike trains is that the input has to be defined and the output is generated by the model.

Once the model is fully implemented the properties of the model that need recording must be decided. Suppose one is interested in the postsynaptic response (psr) of the synapse and the membrane voltage ( $V_m$ ) of the neuron. A recorder object would need to be created and set up to record these measurements. Figure 4.2 summarises how the actual CSIM objects would link up.

Parameter	Measurement Unit	R or RW	Description
Cm	Farads	RW	The capacity of the membrane
Rm	Ohms	RW	The resistance of the membrane
Vresting	Volts	RW	The resting voltage
Vreset	Volts	RW	The reset voltage after a spike
Vinit	Volts	RW	The initial voltage condition at time t=0
Vthresh	Volts	RW	If Vm exceeds Vthresh a spike is emitted
Trefract	Seconds	RW	Refractory period (until it can spike again)
Inoise	Ampere	RW	Standard deviation of noise to be added
Iinject	Ampere	RW	Constant current injected
Vm	Volts	R	Membrane voltage
type	N/A	RW	Type (e.g. inhibitory or excitatory)
Isyn	Ampere	R	Synaptic input current
nIncoming	N/A	R	Number of incoming synapses
nOutgoing	N/A	R	Number of outgoing synapses

Table 4.1: Parameters and descriptions of the LIF neuron. R=Read Only, RW=Read and Write.

Parameter	Measurement Unit	R or RW	Description
tau	Seconds	RW	The synaptic time constant
W	N/A	RW	(Weight) Strength of synapse
delay	Seconds	RW	Transmission delay
psr	N/A	R	(postsynaptic response) Synapse output

Table 4.2: Parameters and descriptions of the static spiking synapse. R=Read Only, RW=Read and Write.

#### 4.3.4 Plotting the Graphs

To plot data from the simulation the data from the relevant recorder channel must be obtained. Gathering the recorded traces from the recorder reveals a struct array. Each struct is representative of one of the readings taken (Vm and psr - defined above). The main fields that need to be emphasized in each struct are 'dt' (seconds) and 'data' (an array of doubles).

- dt - the time discretization for the data recorded, e.g. if it was 0.005, that would mean a reading of the data was taken every 5 milliseconds.
- data - an array containing all the recorded data, e.g. it would contain the voltages when recording Vm.

Time starts at t=0, therefore if dt = 0.005, the first element in the array would represent the reading taken at time t = 5 ms, the second element would represent

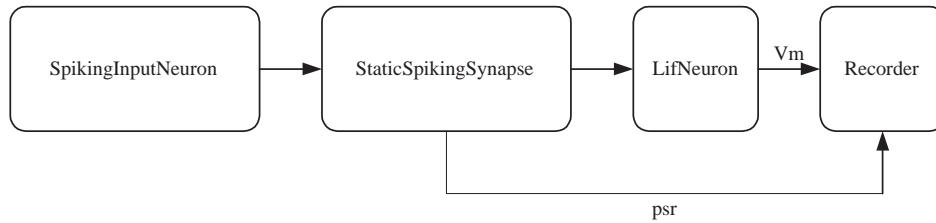

Figure 4.2: A model of how the CSIM objects are connected (adapted from IGI (2004))

the reading taken at time  $t = 10$  ms, etc. The total time of the simulation can be calculated by multiplying the size of the data array by 'dt'.

Once the data from the recorder has been obtained standard Matlab tools can be used to plot it and once plotted in a graph will show the hypothesis to be true or false.



# Chapter 5

## Development

### 5.1 Development Process

Because the requirements are open-ended, it would be highly unrealistic to expect a working simulation of the jellyfish's swimming behaviour to come straight from the requirements. A more realistic approach would be to create models for the identified neural subsystems and then attempt to integrate them to form an overall simulation.

Each model will be built using an iterative design process that builds on the previous versions that have been created. One lifecycle model that suits this development process is discussed by Preece, Rogers & Sharp (2002, p.186).

Although the model is intended for Human Computer Interaction, it can be effectively used here. The simple and iterative attributes of the model suit the experimental nature of the project. The model can be seen in figure 5.1.

As stated above the model is iterative and this can be seen by the multidirectional arrows connecting the various development stages. Not knowing the capabilities of Matlab and CSIM may result in not all requirements being met, so the requirements/tools may have to be re-evaluated and evolved. Inexperience with the two programs may lead to simultaneous work in both design and programming.

The experimental and cyclic approach will require adjustments to the models as they evolve. From prior experience it is known that some of these adjustments will have an undesirable impact on the program behaviour and will be unrecoverable due to the subtlety of the change. It will therefore be important to make backups of the programs as development proceeds, especially when significant findings are made.

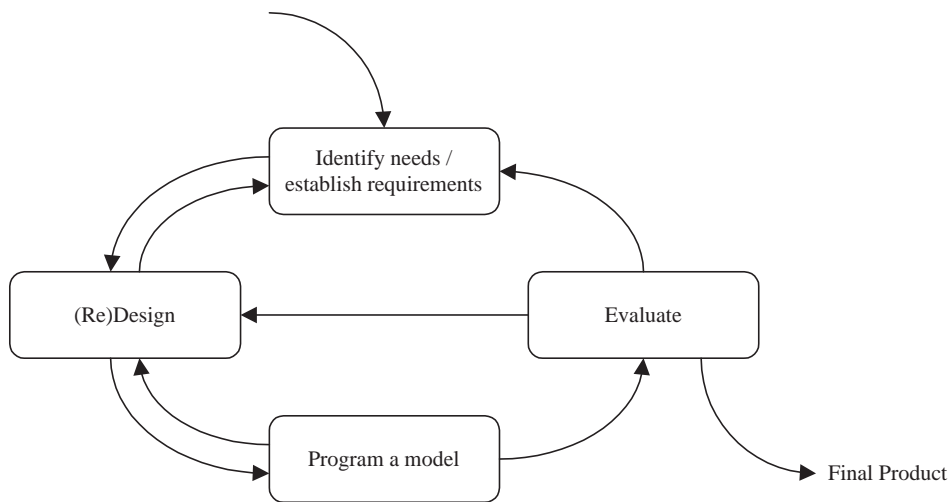

Figure 5.1: A simple lifecycle model for development. Modified from Preece et al. (2002)

This chapter will focus on the final models that were produced. In addition, any particularly interesting development stages in producing these models will also be discussed.

The models will use three elements within CSIM: input spike trains, static synapses and LIFs. Carnell (2005) states the appropriateness of these elements because of their common existence in biological systems. The model is more concerned with the jellyfish's behaviour, so to investigate the mechanics of the different elements would be beyond the requirements of the project.

The code for each of the models can be found in appendix D.

## 5.2 Testing Process

The testing for each model will be carried out in parallel to development and will be part of the interactive process. Black box testing will be the main method of testing.

The output of the models will be predicted from the parameters of the neuronal

elements. For example the time for a spike to travel through a network will be approximated by the synaptic delays and neuron processing times. A successful model will match the predicted output in addition to producing realistic behaviour.

As models become more advanced it may be required to individually test neuronal elements. For example if one of the models requires a neuron that only spikes according to a certain input, the neuron will be tested and developed in isolation and then integrated into the overall model. As models gain advanced functionality, there will be a requirement to check the integration of the new feature.

The models will be tested with a variety of input. This will be a case of simply changing the array of input spike timings. Stress testing will not occur and only what is deemed to be realistic output will be used. Neural networks are sensitive systems and most forms of extreme input will result in abnormal behaviour.

The testing process may appear informal, but will nevertheless be comprehensive. For example, testing the independent CSIM scripts will be very different from the formal process required for a multi-layered, object orientated system in java. The models will be assumed to function correctly if they are stable, operate as needed and have been tested according to the chosen methodology.

### 5.3 Explanation of Graphical Output and Terminology

All the models will generate some form of graphical output. This output will vary between the models and will be dependent on the data that is recorded. To discuss the graphs successfully it is necessary to be aware of the main data patterns that are relevant. Most of the terminologies have not been discussed thus far.

Wikipedia (2005a) covers all the information that will be useful when studying the LIF voltages. A diagram of the different action potential stages is shown in figure 5.2.

The different action potential stages will be used to describe the output from the models. The action potential can be broken down into six ordered steps:

1. A LIF receives some stimulus.
2. With regard to the stimulus:
  - (a) If it is strong enough to push the voltage above the threshold and the LIF depolarises.
  - (b) If it does not reach the threshold the voltage leaks and drifts back towards the resting state.

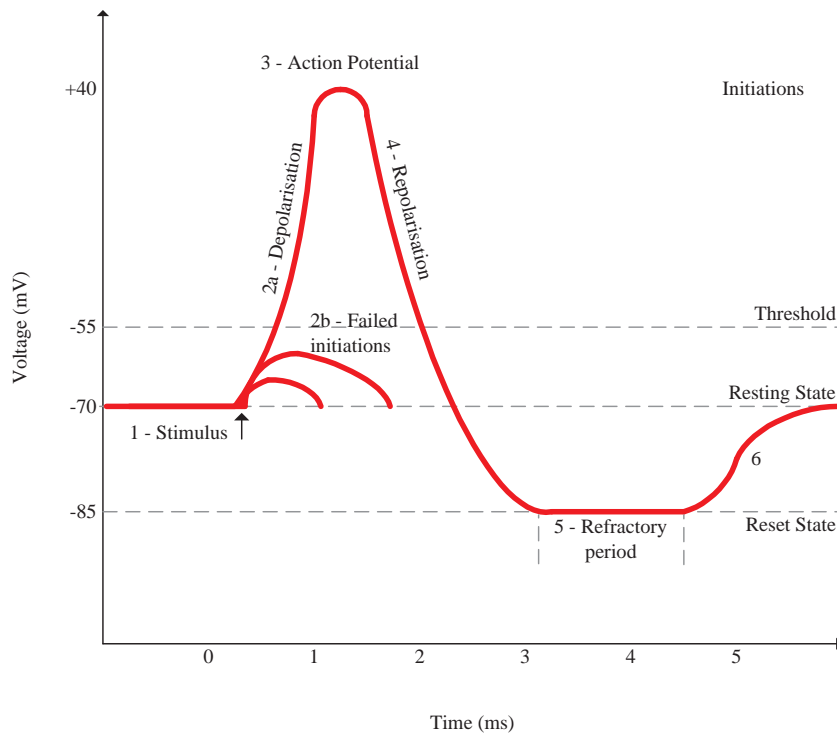

Figure 5.2: The basic stages of an action potential. Modified from Wikipedia (2005a)

3. The LIF depolarises until it reaches the action potential level and a spike is emitted.
4. The repolarisation stage takes place and pushes the voltage to the reset state.
5. The refractory period holds the voltage at the reset rate and while it is in this stage ignores any stimulus.
6. Once the refractory period has ended, the voltage drifts back to the resting state.

Other graphs that will form part of our output will include PSR (Post Synaptic Response). This is the voltage that is emitted from the synapse.

The diagrams will sometimes display spikes that fire from the LIFs. They will be displayed as vertical lines on the graphs and will represent timings only. The y axis position of these lines is irrelevant.

Note that the voltages are negative because they represent the difference between the level outside and inside the neuron.

## 5.4 Model 1 - A Ring of Swimming Motor Neurons

### 5.4.1 Modelled Behaviour

#### Behaviour Description

The first model attempts to create a simulation of one of the SMN rings. All four of the SMN rings that surround the muscle quadrants are thought to be identical, so modelling one of them is adequate. The swimming motor neurons fire in synchrony to produce a balanced muscle contraction.

#### Justification of Choice

We chose to model this behaviour first because it is the core neural element of jellyfish swimming that actually stimulates the swimming muscle. It is a particularly interesting area that is covered extensively in the literature.

One would think that as the signal travels around the ring, each neuron would be innervated at a different time due to synaptic delays. The SMNs have a mechanism that counteracts this delay and this is the main interest point. The literature at this stage of the project did not indicate how the synchrony was achieved and therefore a hypothesis was made.

The output from each SMN in the ring is fairly simple (a single spike) and therefore easy to observe. The graphical output of a synchronous contraction will be easily represented and interpreted.

### 5.4.2 Hypothesis

#### Definition of Hypothesis

The synchronous firing of SMNs is achieved through negligible conduction delays in the electrically coupled network.

## How the Hypothesis will be Tested

If the model results show that the ring fires synchronously, the hypothesis will be true.

The model will be programmed in CSIM and use three elements: spiking input neurons, LIF neurons and static spiking synapses. The short, almost negligible, conduction delays will be modelled by setting short duration delays on the synapses.

## Predicted Result

Even though there is a delay on the synapses, it is minimal. The spiking of the SMNs will be near to synchronous. The spiking of each neuron will be delayed by the cumulative total of the synapses passed so far.

### 5.4.3 Implementation of model

A graphical representation of the model is shown in Figure 5.3:

As described in the literature review, the program has been designed with fifteen leaky-integrate-and-fire neurons. These neurons represent the giant neurons in the SMN network. They are connected by static spiking synapses to form a ring. It is known that within the *Polyorchis* any one of the SMNs can initiate the ring to fire. This has been modelled by having two inputs at LIF 01 and LIF 09. The two neurons are on either side of the ring so that two very different input points can be analysed. Hopefully, the analysis will show that a synchronous ring contraction is obtained from initiating a spike from any one of the LIF neurons. The requirements in section 3.5 state that the input to the network need only be modelled through a single point. The second input was a relatively easy addition and was added because it was thought that it could provide an interesting insight into the behaviour of the network

The recorder functions to record any of the element parameters. It was set to trace three evenly spaced LIFs / synapses around the ring. This gives a good overview of the system behaviour.

The electrically coupled network is implemented by near zero delays (5 ms) on each of the synapses. Obviously the neurons will not fire with exact synchrony, the lag will be approximately 75ms for the neuron at the end of the ring.

Figure 5.3 shows all the objects that needed to be created for the model. The object parameters were all left as the default value unless they had to be changed. It was not a concern that these may not have been accurate values as behaviour was a more important requirement at this stage. The key neuronal parameters are listed below:

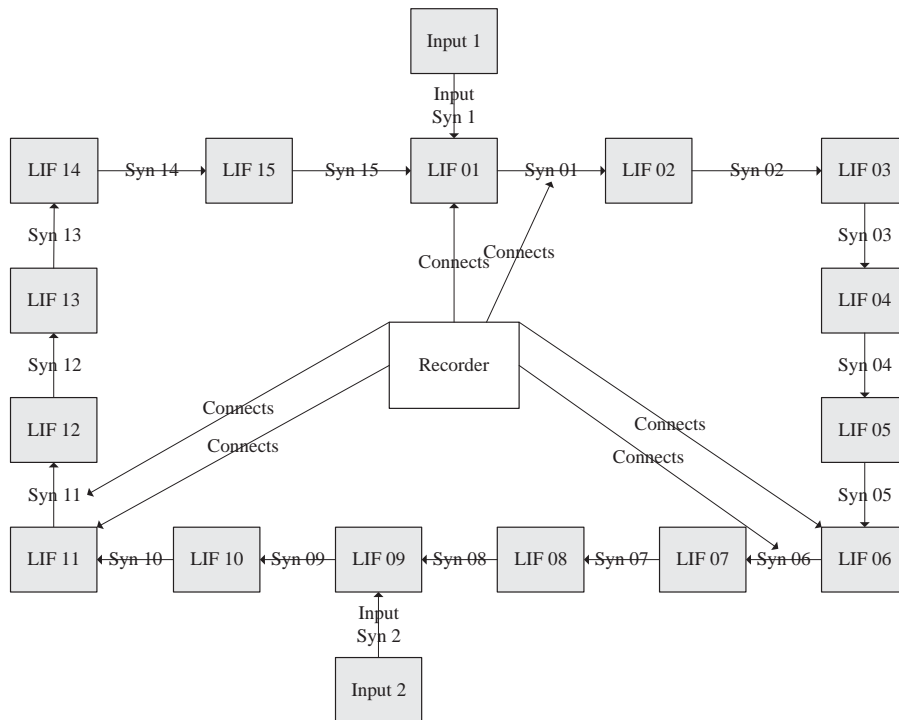

Figure 5.3: A flow chart of Model 1 showing how the CSIM elements connect.

- LIF 01 to LIF 15
  - Threshold = -0.05
  - Resting = -0.06
  - Refractory = 0.10
- Syn 01 to Syn 15
  - Weight = 1.00
  - Delay = 0.005

The LIF neuron threshold voltages were purposely set very close to the LIF neuron resting voltages. This meant that the Neurons were very sensitive and just one spike would make them reach the threshold to fire.

The refractory period is a time period that starts when the neuron fires and stops the neuron from firing again. This was set to 100 ms because the time the action potential would take to travel around the ring was 75 ms. This would stop the neurons firing more than once.

The weight of the synapses was set to 1 because the action potential must not be lost as it travelled around the ring.

## Results - Graphical Output

The output graphs were created using data from the recorder. The data was plotted using standard Matlab tools. The graphs for Model 1 can be seen in figure 5.4 and 5.5.

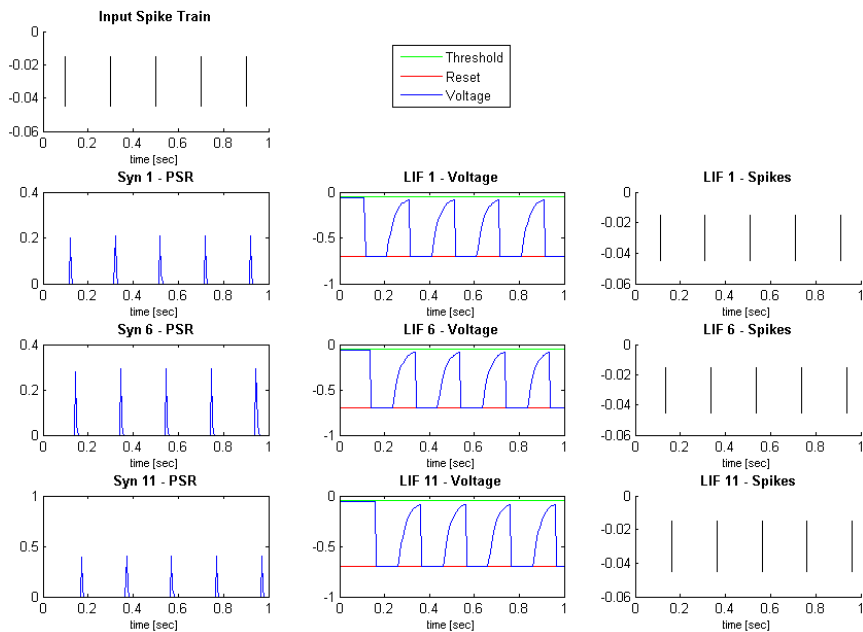

Figure 5.4: Recordings from Model 1 with the input spike train going in through Input 1. The top left graph shows the input spike train. The next nine graphs show readings from the synapses/neurons, with each row showing readings from a different pair. It can be seen the LIF neurons fire at near synchronous times.

The difference between figure 5.4 and 5.5 is that the spike train comes in through different inputs. Figure 5.4 shows the results when input comes in through Input



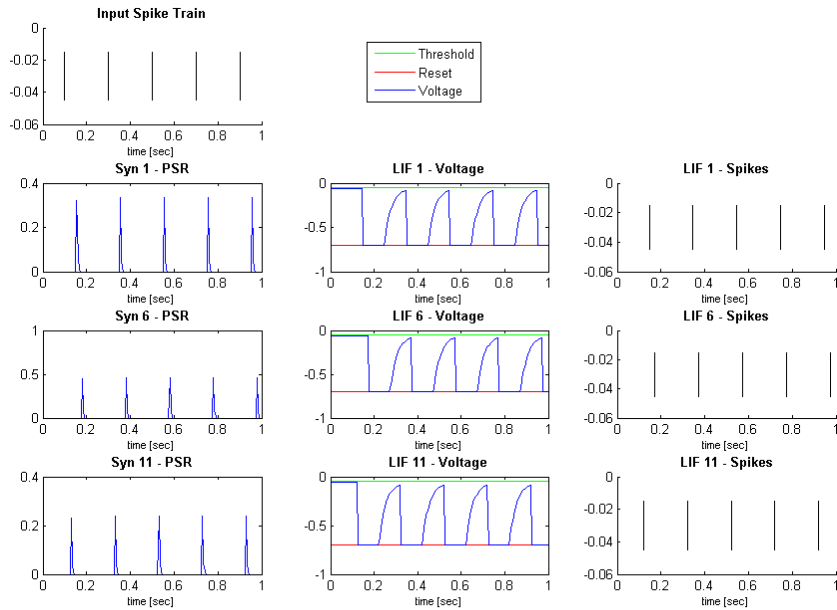

Figure 5.5: Recordings from Model 1 with the input spike train going in through Input 2. The top left graph shows the input spike train. The next nine graphs show readings from the synapses/neurons, with each row showing readings from a different pair. The spiking patterns of the LIFs are now in a different order.

1 and figure 5.5 shows the results when input comes in through Input 2.

Figure 5.4 shows that the three LIFs (LIF 1, LIF 6 and LIF 11) all fire at near synchronous times. It has already been stated that these three LIFs represent a fair sample of the SMNs in the ring because they are equally spaced out around the ring. It can be seen that there is a slight lag in time of 25ms from LIF 1 to LIF 6; and LIF 6 to LIF 11. One would think that such a small delay would not have a major effect on the contraction. It can also be seen that for each LIF the voltages and spikes correspond. The neuron refractory period is displayed for each LIF as the horizontal plane on the reset level. The refractory time stops the ring from continually firing.

In both Figure 5.4 and 5.5 the PSR increases from 0.2 to 0.5 as it circulates around the ring. Presumably this means that the PSR is topping up in value as it goes around the ring.

Figure 5.5 shows that the LIFs spike in a different order when the input is received at Input 2 rather than Input 1. Input 2 penetrates LIF 9 and this explains the reason that LIF 11 fires first, followed by LIF 1 and then LIF 6.

Both figures may be confusing in comparison with the traditional action potential shown in Figure 5.2. It is believed that LIFs in CSIM are modelled to spike as soon as the voltage reaches the threshold and do not model the depolarisation or action potential stages. However, the spikes can be seen to be in synchrony with the repolarisation of the LIFs.

#### **5.4.4 Conclusion**

##### **Validity of Hypothesis**

The hypothesis is rejected. This is not a result obtained from the model but a new finding in the literature. We were wrong to assume that negligible conduction delays caused the SMNs to spike synchronously. Megill (2005) states that the synchrony occurs due to a decaying action potential duration. This feature is integrated into the next experiment.

##### **Analysis of Results**

The actual model worked for our hypothesis, but as stated above, our hypothesis was incorrect. The expected behaviour of slightly staggered spiking as the signal travelled around the ring was true. The SMNs in the ring only spiked a single time because of the refractory periods set for the SMNs.

##### **Interesting/Problem areas**

There were a few teething problems when creating the model. These were mainly due to the inexperience with CSIM and Matlab.

A more significant problem was determining a way to stop the ring from continually firing. As stated above, this problem was resolved by setting the refractory period on the LIFs. The timing value on all neurons was set so that when the signal looped back to the LIF that initiated the spike, it could not fire a second time. Another method that was considered was adjusting the synaptic weights so that the signal decayed by the time it had looped once around the ring. This method would have been complicated to implement, as the weight variable would have to be set to such a precise level.

The issue of whether jellyfish use a suitable refractory period, or use synaptic weightings to prevent the continual firing of the ring, is outside of the scope of this project, but would form a biological research topic for the future. This

model indicates that the former provides a more likely explanation for the phenomenon.

### **Strengths and Weaknesses of Model**

The main weakness of the model is that it is unrealistic to assume that such short delays occur on the synapses between LIFs (the literature does not substantiate this view). After producing this model it was discovered that the Jellyfish modulates the synaptic delays in the ring through a decaying action potential duration (Megill 2005). This misunderstanding made the model unrealistic in its design.

The model has near synchronous firing of the synapses, but this may well not be enough. All the literature reviewed stated an exact synchronous firing.

The model only allows input through two of the neurons. This is unrealistic as the any one of the SMNs can fire due to their photosensitivity. However, this was an area identified in the design stage that would be adequately modelled by just one input to the ring. The fact that the model had the option of two inputs provides an additional benefit.

The timing and electrical properties of the model may not be realistic. Unfortunately the literature did not provide all of the details needed. Although this was one of the requirements it was less important than reproducing the behaviour of the SMN ring. One particular example is that the reset rate of each LIF is set to  $-0.7V$ . This voltage level is much greater than the other levels ( $-0.05V$  and  $-0.06V$ ) and is very far off the threshold and the resting voltages. This value was adjusted to obtain the required behaviour.

There is a close match to the physical characteristics of the jellyfish as it contains fifteen LIFs, which matches the number of SMNs in the ring. For the development of future models it will be considered appropriate to reduce this number. It is expected that the concept of synchronous spiking can be proved just as easily with a fewer number of neurons and it would be a simpler model to comprehend.

### **5.4.5 Future Work**

All future work is brought together and discussed in its entirety in sections 6.4 and 6.5.

## **5.5 Model 2 - A Ring of Swimming Motor Neurons (Improved)**

### **5.5.1 Modelled Behaviour**

#### **Behaviour Description**

The second model attempts to create the same behaviour as Model 1. This behaviour is to simulate one of the swimming motor neuron rings. The key new behavioural attribute is the synchronous firing of the SMNs from a single spike into the ring.

#### **Justification of Choice**

It was identified that Model 1 used an unrealistic mechanism to synchronise the spiking of the SMNs. The mechanism produced inaccurate results, as the firing occurred in a staggered pattern and throughout the literature exact synchrony has been labelled as essential. On the basis of Megill (2005), it is hypothesised that the synchrony arises from varying action potential durations. The same justifications listed for Model 1 also remain.

### **5.5.2 Hypothesis**

#### **Definition of Hypothesis**

The synchronous firing of the SMNs is as a result of a decaying action potential duration that is transmitted between the SMNs.

#### **How the Hypothesis will be Tested**

If the model results show that the ring fires synchronously, the hypothesis will be true.

Model 1 will form the basis of the model. The decaying action potential duration will be modelled with hard coded synaptic delays that link the SMNs to output neurons.

## Predicted Result

It is forecast that the combined total of the cumulative delay from the ring synapses and the various hard coded synaptic delays should be equal for every neuron in the ring. Such a system would produce an exact synchronous contraction. It is thought that the hard coded delays may reduce the flexibility to input at any point in the SMN ring.

### 5.5.3 Implementation of model

CSIM does not directly offer the facility to implement a decaying action potential. Instead this mechanism was hard coded into the model with the use of differently timed synaptic delays. This restriction is commented upon in section 6.3. With the exception of the settings for this new mechanism, the same neuron and synapse settings from Model 1 were maintained. Once again there was focus a on creating a single SMN ring as all four are thought to be identical. Figure 5.6 shows a graphical representation of Model 2.

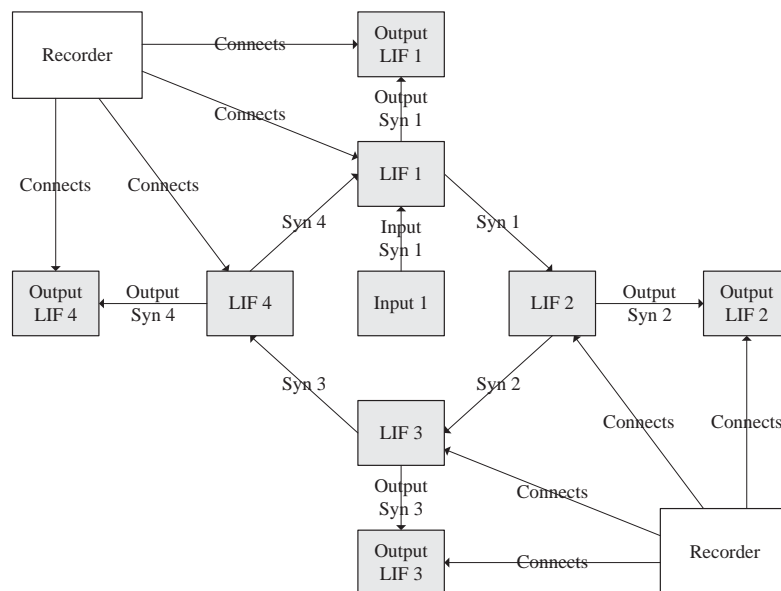

Figure 5.6: A flow chart of Model 2 showing how the CSIM elements connect.

Model 1 had two different inputs to the network. Figure 5.6 shows that Model

2 has one input. A single input still meets the requirements that were set in the design and is necessary to ensure the hard coding used for synchronous firing remains effective. The model represents four SMNs. It was identified in section 5.4.4 that the concept of synchronous spiking could be proved with a fewer number of neurons. The result is a model that is simpler to comprehend.

Figure 5.6 shows that Input 1 directly links to a ring; the specific point of connection being with LIF 1. The synapse connecting the input to LIF 1 (Input Syn 1) has a delay of 10ms. LIF 1 forms a ring with LIF 2, LIF 3 and LIF 4. Each synapse within this ring (Syn 1, Syn 2, Syn 3 and Syn 4) also has a delay of 10ms. Table 5.1 shows the cumulative delay for the action potential to reach each LIF within the ring. The last column in the table shows an appropriate counteraction time to ensure the neurons fire synchronously.

Neuron	Cumulative Delay (ms)	Explanation	Timing to counteract the cumulative delay (ms)
LIF 1	10	Input Syn 1	40
LIF 2	20	Input Syn 1 + Syn 1	30
LIF 3	30	Input Syn 1 + Syn 1 + Syn 2	20
LIF 4	40	Input Syn 1 + Syn 1 + Syn 2 + Syn 3	10

Table 5.1: An overview of the synaptic delays in Model 2.

It has already been stated that the decaying action potential duration cannot be replicated in CSIM. Instead the counteraction times from table 5.1 were hard coded in the form of synaptic delays (Output Syn1; Output Syn2; Output Syn 3; and Output Syn 4). The Output LIFs in essence model the spiking swimming motor neurons.

Figure 5.6 displays two recorders. These are actually the same recorder and have been drawn like this to make the graphical representation less cluttered. It can be seen the recorder traces data for most of the elements in the model.

## Results - Graphical Output

The output graphs for Model 2 can be seen in figure 5.7 and 5.8. The difference between the two figures is that they have slightly different axis scales and that they receive different input spike trains.

Figure 5.7 is the more simple output and so this will be analysed first. LIF 1, LIF 2, LIF 3 and LIF 4 display a staggered spiking pattern showing that the action potential reaches these LIFs at different times.

The staggered pattern is due to the synaptic delays within the ring (Syn 1, Syn 2, Syn 3 and Syn 4). The output LIFs all come back in synchrony due to the

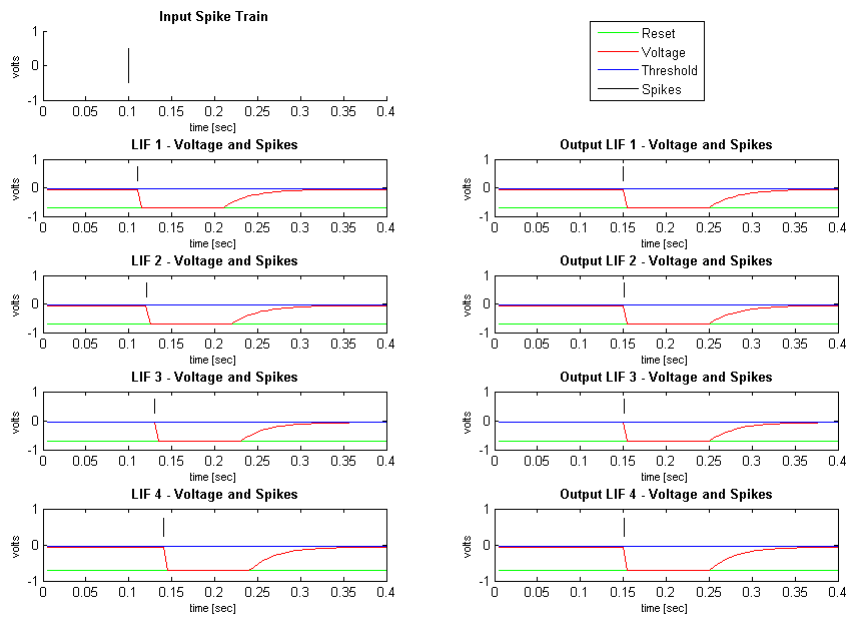

Figure 5.7: Recordings from Model 2. The input emits a single spike into the model at 100ms. The top left graph shows this input spike train. The other graphs on the left show how the LIFs spike in a staggered pattern. The graphs on the right show how the synaptic delay brings the spiking into synchrony.

hard coded synaptic delays (Output Syn1; Output Syn2; Output Syn 3; and Output Syn 4) put in place to model the decaying action potential duration.

Figure 5.8 shows how the model responds to two spiking inputs. If this second spiking input would have occurred at 0.15 seconds, LIF 1 would have still been in its refractory period and would have ignored this stimulus. It can be seen that the Output LIFs maintain their synchrony with more than one spiking input.

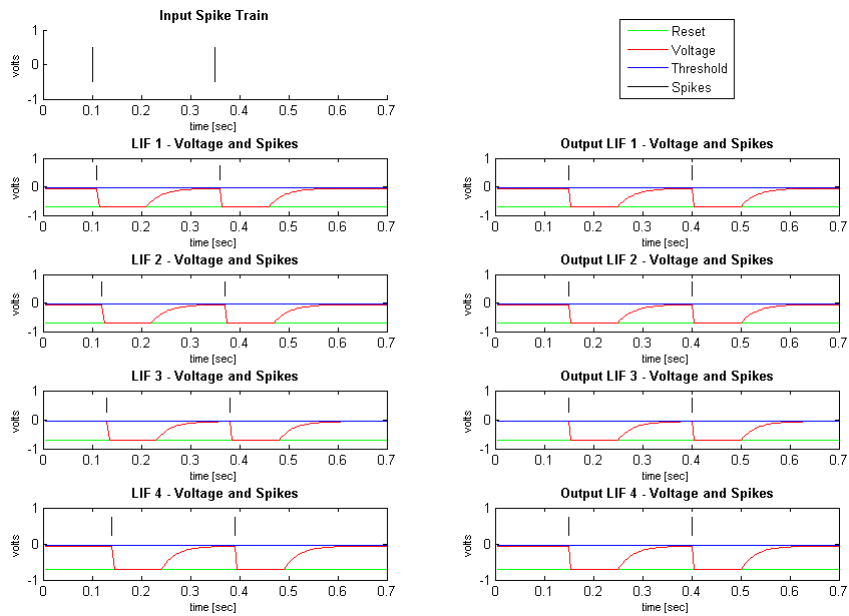

Figure 5.8: Recordings from Model 2. The input emits a double spike into the model at 100ms and 350ms. The top left graph shows this input spike train. The next eight graphs show readings from the Ring LIF and Output LIF pairings, with each row showing readings from a different pair. It can be seen the model deals with multiple input spikes.

## 5.5.4 Conclusion

### Validity of Hypothesis

The hypothesis of a decaying action potential is a definite improvement from the hypothesis identified in Model 1. The hypothesis was backed up by the literature and gave us a solid platform to work from. The actual way we modelled the decaying action potential was inaccurate, but it gave us the primitive model that we identified in the requirements.



## **Analysis of Results**

The model met our requirement for the behaviour of synchronous spiking. The action potential duration decay was modelled in a primitive way due to the limitations of CSIM. In overview, the SMNs in the ring contracted a single time in a synchronous manner. The method in which the decaying action potential duration was modelled in CSIM does not invalidate the hypothesis.

## **Interesting/Problem areas**

Due to the hard coding, the model would only contract synchronously if input came in through a single designated neuron. This met the design requirements in section 3.5 but may not be similar to a real life jellyfish. The literature implies that the SMNs will permit input at any point. This highlights the fundamental problem of modelling the decaying action potential duration with hard coded synaptic delays.

Figure 5.8 shows that the model is able to cope with several input spikes. The refractory period on the LIFs would stop the neuron from firing too frequently. It is likely the jellyfish has an optimum number of muscle contractions to promote efficient swimming. A refractory period mechanism in the SMNs could be used to modulate the maximum number of muscle contractions per second. This is one area that would benefit from further biological research.

## **Strengths and Weaknesses of Model**

The main feature of the SMNs is the decaying action potential duration. The technique used to emulate this feature is adequate for this initial model. There would be difficulties (such as limiting the input through SMN) if the model were to be developed further and integrated into other neural subsystems.

The success of the model relies upon the position of the single input to the model. If the input spike train was connected to a different LIF, all synchrony would be lost. Any more than one input to the model would also deem the model ineffectual. Again, both of these problems occur as a result of the hard coded output synapses. If the decaying action potential duration was modelled in a more accurate way these problems could be avoided.

It is believed that the physical properties of this model are not as realistic as Model 1. Model 2 only contains four SMNs whereas Model 1 contains fifteen SMNs. However conceptually the models are no different. During the implementation of the model it was realised that giving the synapses a 100connectivity parameter is probably unrealistic.

Progress has been made and this model satisfies more of the requirements than Model 1. The SMNs fire at exact synchronous times. This was the main behav-

ioural requirement and it is therefore fair to state that the program provides a good overall initial model for a SMN ring.

From the modelling results conducted it can be deduced that the action potential timings within the jellyfish are very meticulously structured. It has been identified that the action potential duration decays between the SMNs. Jellyfish come in a variety of sizes and grow as they age. We must assume therefore that the synapses grow and the associated delay becomes greater. The model shows that in order for the synchronous firing to occur there would need to be an action potential duration decay proportional to the increase in size of the jellyfish as a consequence of its growth. This is a hypothesis that could be investigated as part of a future biological research programme.

### **5.5.5 Future Work**

All future work is brought together and discussed in its entirety in sections 6.4 and 6.5.

## **5.6 Model 3 - A Pacemaker**

### **5.6.1 Modelled Behaviour**

#### **Behaviour Description**

This third model attempts to simulate the pacemaker unit. It has already been identified that the function of the pacemakers is to output regular action potentials to the inner nerve ring. These spikes must be emitted at a constant rate and until the unit is switched off.

#### **Justification of Choice**

Although not much about the pacemaker is identified in the literature its presence is acknowledged. It is identified that the pacemaker is an important neural element in the swimming system of a jellyfish, and therefore not modelling it would be a significant omission. It is hypothesised that the pacemaker property of the jellyfish is generated from a self-sufficient unit.

It is interesting that a unit that can produce regular action potentials from a single stimulus until it is switched off. How this unit maintains its energy is of interest to the hypothesis.

## 5.6.2 Hypothesis

### Definition of Hypothesis

The pacemaker unit is self-sufficient in producing regular spiking output once it has been switched on by an external stimulus. It will only stop producing output when an inhibitory action potential is sent to the system.

### How the Hypothesis will be Tested

The hypothesis will be shown to be true if a regular spiking pattern is produced.

A potential pacemaker design will be proposed. The model should use the three usual CSIM components and in addition an inhibitory input to switch the pacemaker off. A feedback loop will recycle the action potential to maintain the continuity of the outputted action potentials.

### Predicted Result

Initially, the model should output regular action potentials. Whether the unit will continue to produce them and maintain its energy infinitely is unknown. It will also be the first time an inhibitory input is used and there may be difficulty creating this.

It is predicted that the frequency of output will be equal to the sum of the synaptic delay in the cyclic unit.

## 5.6.3 Implementation of model

Figure 5.9 displays a graphical representation of Model 3. The pacemaker design derives from an idea provided by Carnell and Richardson of the University of Bath, but has been implemented in full by the author.

In the literature the pacemaker is only mentioned as a ‘black box’ system. No explanation of how the mechanism works is given. The model has been designed with the minimum number of neural elements to provide the regular output needed.

LIF 1 is the core element in the model. It takes the inputs and then passes the signal to both LIF 2 and LIF 3. LIF 3 acts as the spiking output neuron and LIF 2 passes the action potential back to LIF 1. LIF 1 and LIF 2 can be considered the neurons that recycle the action potential.

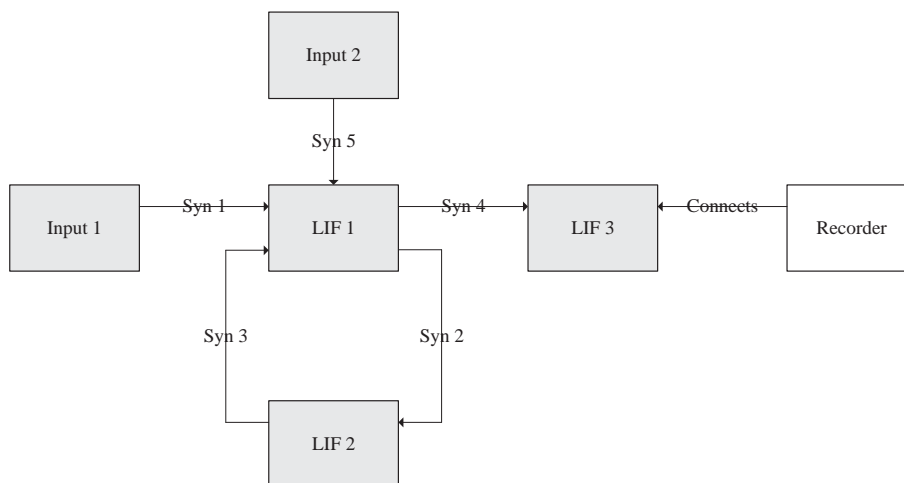

Figure 5.9: A flow chart of Model 3 showing how the CSIM elements connect.

The two inputs to the network are both routed through LIF 1. Input 1 is an excitatory spiking input and is similar to the inputs found in previous models. The function of Input 1 is to switch the pacemaker on. Input 2 serves to switch the pacemaker off. The spiking input neuron is exactly the same as Input 1, but the synapse that connects this input to LIF 1 is different. Specifically the synapse weight is set to a negative value. The result is a neuron that inputs inhibitory spikes into LIF 1.

The LIF parameters have been copied from Model 2. These values were utilized as they displayed the behaviour needed for this model. All the synaptic delays have been increased to 100ms to make the regular rhythm the pacemaker outputs more explicit.

Table 5.2 shows the predicted route that the action potential will follow for the first five output spikes. It also shows their predicted timings, which have been calculated by adding the synaptic delay times. It is thought that a similar pattern will occur until Input 2 switches the unit off.

The recorder for this model only gathers voltage levels and spikes from LIF 3. This is the neuron that should display the regular output.

There was debate of how to create the inhibitory input to stop the pacemaker. The CSIM documentation suggested two ways of creating such an input. One was to change the 'type' parameter for the spiking input neuron. This was a Boolean field and was either excitatory or inhibitory for 0 and 1 respectively.

Spike	Route of Action Potential and Explanation	Spike emission time (s)
1	Input 1, Syn 1, LIF 1, Syn 4, LIF 3	0.2
2	Input 1, Syn 1, LIF 1, Syn 2, LIF 2, Syn 3, LIF 1, Syn 4, LIF 3	
3	Input 1, Syn 1, LIF 1, Syn 2, LIF 2, Syn 3, LIF 1, Syn 2, LIF 2, Syn 3, LIF 1, Syn4, LIF 3	0.6
4	Input 1, Syn 1, LIF 1, Syn 2, LIF 2, Syn 3, LIF 1, Syn 2, LIF 2, Syn 3, LIF 1, Syn 2, LIF 2, Syn 3, LIF 1, Syn4, LIF 3	0.8
5	Input 1, Syn 1, LIF 1, Syn 2, LIF 2, Syn 3, LIF 1, Syn 2, LIF 2, Syn 3, LIF 1, Syn2, LIF 2, Syn 3, LIF 1, Syn 4, LIF 3	1

Table 5.2: The route the action potential follows for the first five output spikes

The other option was to weight the synapse with a negative value. This had the same effect and sent negative impulses to the neuron. The synapse weight was the chosen method as it was found to be easier to implement.

## Results - Graphical Output

The output graphs for Model 3 can be seen in figure 5.10 and 5.11. Figure 5.10 shows the pacemaker outputting regular spikes. Figure 5.11 shows the pacemaker being switched off.

Figure 5.10 shows that Model 3 produces the pacemaker behaviour intended. The single spike input that creates regular output spikes represents a model that conforms to the main requirements.

Further analysis of Figure 5.10 revealed that the LIF 3 spikes were 204 ms apart. The synaptic delays account for 200 ms of this delay. The other 4ms comes from the time it takes LIF 1 and LIF 2 to depolarise and reach the action potential.

Figure 5.11 shows the inhibitory input stopping the pacemaker. It can be seen that two inhibitory spikes from Input 2 stop the pacemaker from outputting action potentials. The timing and number of these inhibitory spikes proved to be very important. This is discussed further in section 5.6.4.

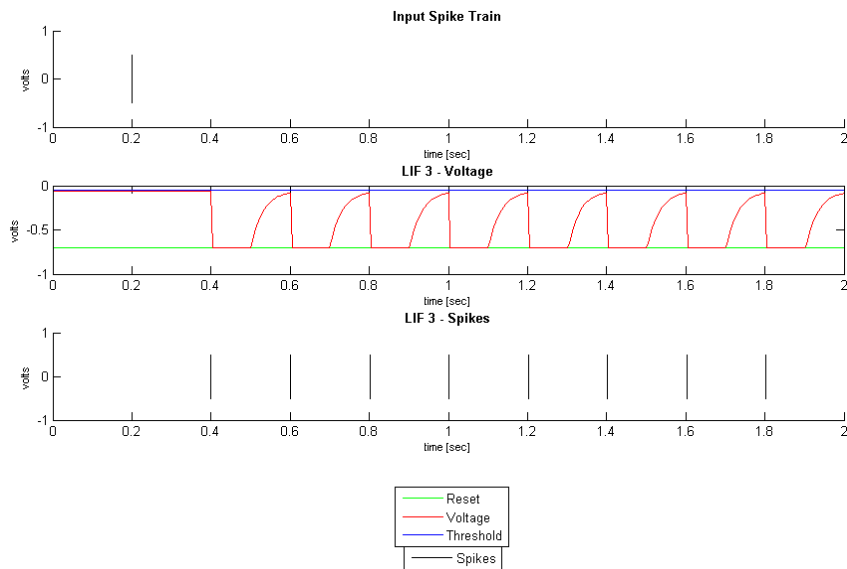

Figure 5.10: Recordings from Model 3. The top graph shows that the input emits a single spike into the model at 0.2 s. The two other graphs below this show the regular pattern of LIF voltages and spikes.

## 5.6.4 Conclusion

### Validity of Hypothesis

The model produced the regular output specified in the requirements. By carefully selecting the quantity and timings of the inhibitory input, we managed to switch the pacemaker off.

Therefore the hypothesis has been upheld. However it must be noted that there is no biological evidence that suggests the model is realistic. The model only produces a possible mechanical solution as to how the pacemaker system may operate in real life.

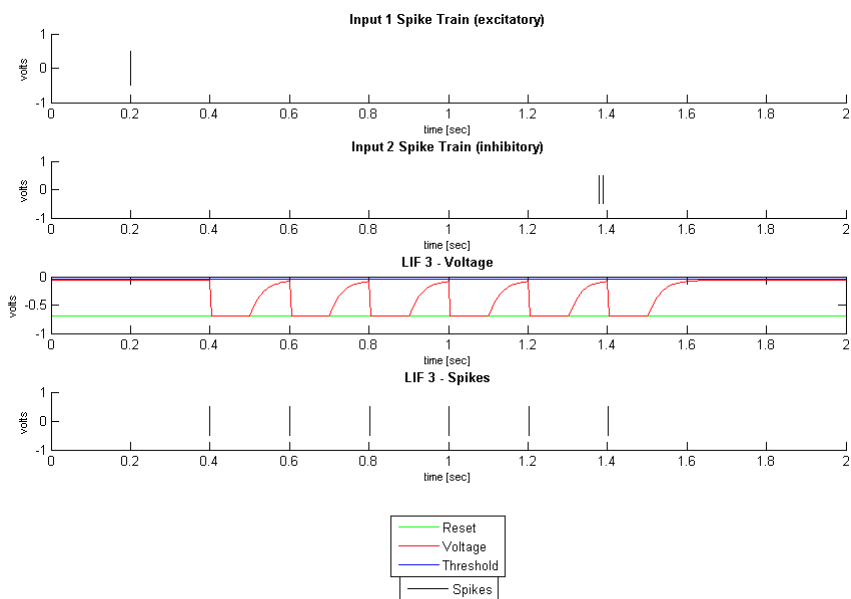

Figure 5.11: Recordings from Model 3. The top graph shows the excitatory input (Input 1) emitting a single spike into the model at 0.2 s. The second graph shows the inhibitory input (Input 2) emitting two spikes prior to 1.4 s. The two other graphs show the stopping and starting of the regular pattern of LIF voltages and spikes.

### Analysis of Results

The prediction for the frequency of the output was correct and this is shown in the model as the sum of Syn2 and Syn 3. It was also noticed that any other synapses in the system (Syn 1 and Syn 4) acted as an initial delay to the system.

### Interesting/Problem areas

The main concern with creating the pacemaker was that the recycled action potential might catch up with the one in front of it. To illustrate this point, suppose Synapse 4 had a 250ms delay. This is illustrated in figure 5.12.

Presume that Input 2 has no input to the model and let  $t$  represent the time

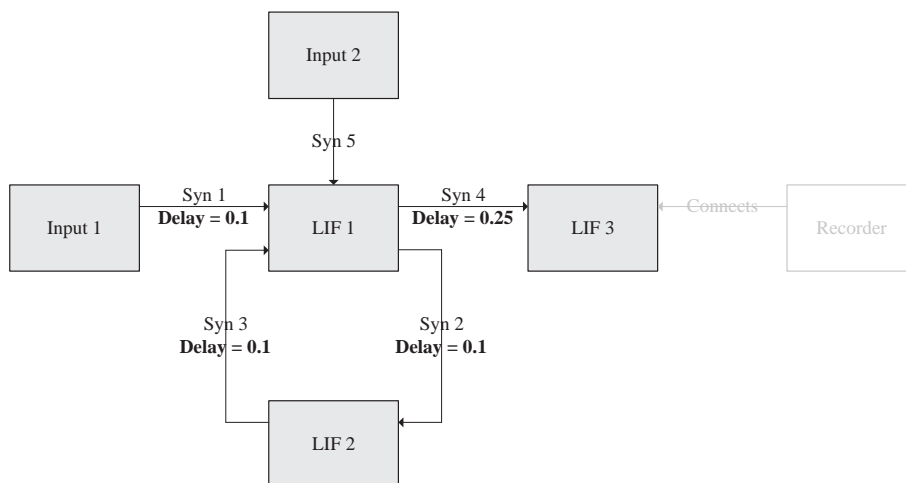

Figure 5.12: A flow diagram of Model 3 with different Syn 4 having a different delay.

that the Input 1 spikes.

The first action potential to reach Syn 4 would be delayed by 0.1 seconds (Syn 1) and would get there at  $t + 0.1$  seconds. Synapse 4 would delay this action potential and send it to LIF 3 at  $t + 0.35$  seconds (Syn 1 and Syn 4).

The second action potential to reach Syn 4 would be delayed by 0.3 seconds (syn 1, syn 2 and syn 3) and would get there at  $t + 0.3$  seconds.

This means Synapse 4 would be dealing with two action potentials:

- One at the time period 0.1 - 0.35 (as a result of the direct path)
- One at the time period 0.3 - 0.55 (as a result of the feedback loop)

This could have disrupting consequences and put the first two spikes out of regular firing. In conclusion:

- If a standard time delay of  $d$  is set for each synapse the pacemaker will output spikes at  $t + d$ ,  $t + 2d$ ,  $t + 3d$ , etc.
- If custom synapse delays are set the first action potential must not catch up with the second action potential. The rule to follow is that the sum



of the delay for syn 2 and syn 3 must be greater than the delay for syn 4.  
i.e.

$$\text{Syn 2 (delay) + Syn 3 (delay)} > \text{Syn 4 (delay)}$$

Initially there was a difficulty in switching the unit off. One spike resulted in the action potential being ‘jittered’ out of timing. This is shown in figure 5.13. It indicates that a single inhibitory input just before 1.4 seconds has a knock on effect and put the subsequent pulses out of time.

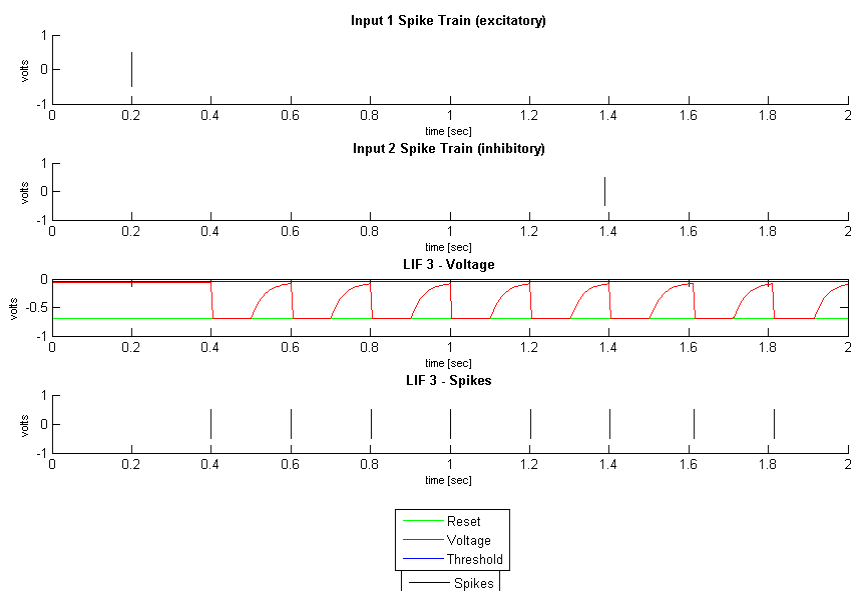

Figure 5.13: Recordings from Model 3. The top graph shows the excitatory input (Input 1) emitting a single spike into the model at 0.2 s. The second graph shows the inhibitory input (Input 2) emitting a single spike at 1.4 s. The two other graphs show that the output of the pacemaker is put out of synchrony by being delayed at 1.6 and 1.8 s.

Figure 5.11 shows that two spikes resulted in the action potentials being completely stopped. Presumably a single inhibitory spike did not have enough energy to take the voltage level of the neuron sufficiently below the threshold level.

The reason the neuron did not stop firing on a single spike was thought to be

one of two reasons:

- Either the neuron had not been innervated at the correct time with the inhibitory spike,
- Or the inhibitory spike had not had enough of an effect to take the voltage a sufficient distance from the threshold and that the next excitatory spike would still result in the voltage reaching the threshold.

The approach taken was to insert two inhibitory spikes into the network. This more than doubled our chances of switching the pacemaker off as both the quantity of inhibitory spikes and times the inhibitory spikes covered had increased. Further work for this project would have been to determine whether different phasing of an inhibitory spike would have switched the unit off.

If this model is valid, to stop the pacemaker unit in a real jellyfish, the behaviour of an inhibitory pulse would work on one of the following principles:

- On the assumption that the inhibitory pulse is time critical it is expected that this spike will always have the same phasing with respect to the output waveform frequency.
- On the assumption that the inhibitory pulse is more sensitive to total energy input it is expected that there would be more than one spike in a period.
- On the same assumption as the preceding bullet, an alternative mechanism would be to have a stronger stimulus spike than the excitatory spikes creating the pacemaker activity.

Another issue that was of concern was having two outputs from a single neuron. This had not been applicable in any of the previous models. Fortunately from a modelling perspective, CSIM operated in the way expected, sent identical action potentials to both receiving neurons, and did not divide the action potential between them.

### **Strengths and Weaknesses of Model**

During the testing of the model, the pacemaker continued producing regular spiking output indefinitely. This is probably an unrealistic representation of the real life situation where energy would be lost by other means such as voltage leaks through membranes that were not 100% insulated. A more realistic approach would have been to not have 100% connectivity weightings on the synapses. The pacemaker is known to output until it is switched off, so there must be another mechanism within the jellyfish that sends more energy into the unit when the energy level fell below a certain level. This is a point where further biological research is required (see section 6.4).

### **5.6.5 Future Work**

The lack of biological data on the neural structure of the pacemaker has led to a highly speculative design of this model. Further work in this area is brought together and discussed in its entirety in sections 6.4 and 6.5.

## **5.7 Model 4 - Inner Nerve Ring**

### **5.7.1 Modelled Behaviour**

#### **Behaviour Description**

The fourth model attempts to create a simulation of the Inner Nerve Ring. Specific points of interest include how the ring spikes synchronously and whether or not the ring fires with more than one input.

From the design we know that the INR forms a ring of 100 neurons at the margin of the jellyfish bell. The same approach to Model 2 will be followed, whereby we try to prove the same concept in a simpler way using four neurons.

#### **Justification of Choice**

The INR completes the modelling of the identified neural elements that are essential for jellyfish swimming. The literature does not identify how the INR maintains its synchrony and it will be hypothesised that it uses similar decaying action potential durations to those found in the SMNs. The more important factor in the model is representing an INR that spikes on more than one input. This hypothesis is made because if the INR receives spikes from many systems, and if it spiked on every input, it would be continually spiking. The input for the INR will come from two systems that are capable of initiating the neuron simultaneously.

### **5.7.2 Hypothesis**

#### **Definition of Hypothesis**

The INR will only spike on sufficient input. The input is dependent on both quantity and timing of spikes. If the INR spikes it will do so synchronously, using decaying action potential durations similar to that found in the SMNs.

## How the Hypothesis will be Tested

The hypothesis will be shown to be true if it takes two or more spikes to make the ring fire (one spike will not cause it to fire).

Spike input trains will be used to artificially model the pacemaker and the ONR. These two trains connect to a neuron that only spikes on sufficient stimulus. This neuron will then pass the action potential to a delay mechanism similar to that found in Model 2.

## Predicted Result

The ring is not expected to fire on a single spike. The INR should be able to fire on stimuli from either the ONR or the pacemaker. It should also be able to fire from a combination of the two, even though the effect of each separately would be insufficient to cause it to fire.

The synchrony mechanism has been developed in a previous model. Therefore we only have to cope with the integration of this mechanism into the new system.

### 5.7.3 Implementation of model

A graphical representation of Model 4 is shown in Figure 5.14:

LIF 1, LIF 2, LIF 3 and LIF 4 represent the Inner Nerve Ring. Spike input trains are used to artificially model the pacemaker (Input 1) and the ONR (Input 2). These two trains connect to a threshold neuron (Thres LIF) that fires if it receives enough stimuli. The threshold neuron is the only input to the ring.

The requirements specify that the ring must only spike after sufficient stimulus. Sufficient stimulus was not defined explicitly, but is interpreted as more than one spike. The parameters for the threshold LIF had to be different to the rest of the LIFs. Most of the LIFs within the previous models had fired on a single spike. There were three options to generate such behaviour:

1. Change the parameters of Input Syn 1 and Input Syn 2
2. Change the parameters of the Thres LIF
3. Change the values of all three elements

It was decided that the simplest option would be to change the parameters of the two input synapses to the threshold LIF. Option 2 was rejected because the LIF element contained far more parameters than the synapse elements. Option 3

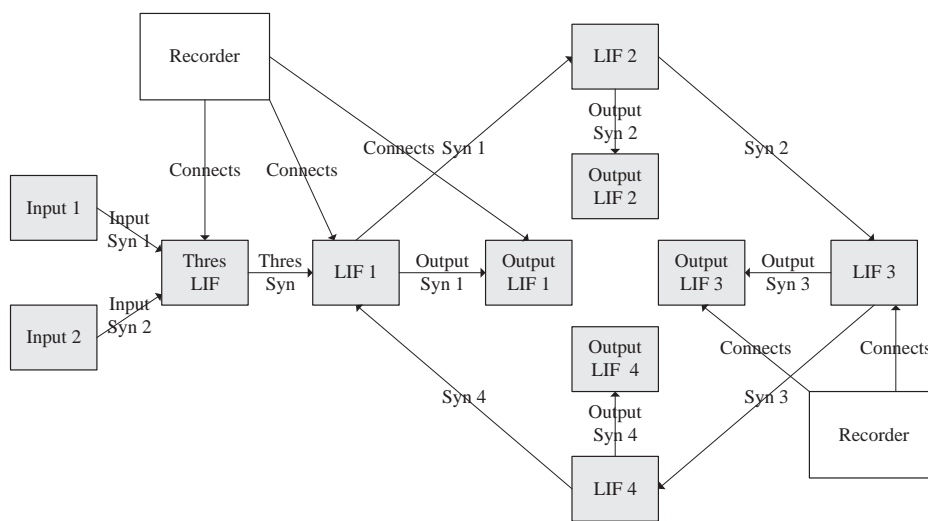

Figure 5.14: A flow chart of Model 3 showing how the CSIM elements connect.

was not considered because it seemed unnecessarily complex. Since all achieved the same results, in the interest of time, the simplest option (1) was chosen.

The synapse was required to adjust the action potentials so LIF 1 received less of a signal and did not fire from one spike. Two parameters were adjusted to get the required behaviour: tau - the synaptic time constant; and W - the synaptic weighting. The final values that produced this behaviour were:

- Thres Syn
  - $W = 0.000001$
  - $\tau = 0.0003$

It was not clear whether these values provided a realistic representation of the real life behaviour. The literature did not contain such information. However,

the value set for the parameter passed the principal requirement of getting accurate behaviour for the INR. The general LIF reset voltage was set to a different value to make graphical output more meaningful. This had no significant effect on the neuron.

Conclusions from Model 3 stated that modelling the synapses with 100 percent connectivity was unrealistic. To improve on this, the synaptic weights were changed to 0.5 to represent some form of inefficiency such as leaking voltage.

The requirements stated that each LIF in the ring must spike synchronously. The system was therefore designed in a similar way to the SMN synchrony mechanism. Hard coded delays were put in place using Output Syn 1, Output Syn 2, Output Syn 3 and Output Syn 4.

Similarly to Model 2, the two recorders shown in the diagram represent the same object. The recorder connects to many objects. Thres LIF was connected to show that it would not spike on a single stimulus. LIF 1 and LIF 3 were chosen to give a fair representation of the internal neurons before the hard coded synaptic delays had been put in place. Output LIF 1 and Output LIF 3 were chosen to show that the outputs from the rings fired synchronously.

## Results - Graphical Output

The output graphs for Model 4 can be seen in figure 5.15 and 5.16.

Figure 5.15 shows that the Ring takes many inputs. The model was tested with the following combinations of inputs:

- One from the pacemaker, One from the ONR: result - no fire
- Two from the pacemaker, One from the ONR: result - no fire
- Three from the pacemaker, Zero from the ONR: result - no fire
- Three from the pacemaker, One from the ONR: result - fire

It can be seen that the threshold neuron takes four spikes within 120 ms to fire. It can then be seen that the internal LIFs spike in a staggered pattern and the Output LIFs spike synchronously. This pattern is identical to the synchronisation method in Model 2.

Figure 5.16 shows that the first two spikes from the pacemaker do not make Thres LIF fire and the voltage returns to its resting state. The spikes from the ONR are fairly dense and the outcome is the Thres LIF firing twice. The refractory period on LIF 1 results in it only firing once. This mechanism may prove quite useful in modulating the output from the INR if a jellyfish received an abundance of input through the ONR and pacemaker.

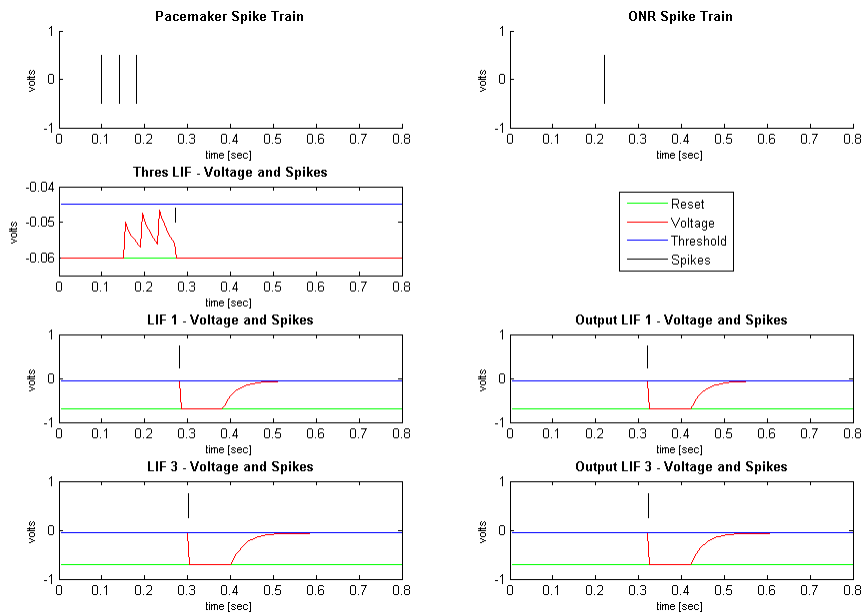

Figure 5.15: The two graphs at the top of the figure show input spike trains recordings for the Pacemaker and the ONR. The graph below shows the Threshold LIF firing after 4 input spikes from a combination of the pacemaker and ONR. The next two rows show that the ring fires in a staggered fashion, but the output LIFs fire synchronously.

### 5.7.4 Conclusion

The INR will only spike on sufficient input. The input is dependent on both quantity and timing of spikes. If the INR spikes, it will do so synchronously using decaying action potential durations similar to that found in the SMNs.

### Validity of Hypothesis

The Threshold neuron combined the input from two separate spike trains that represent the ONR and pacemaker. It has been shown that the ring will only spike on a sufficient amount of input. The ring successfully integrates the decaying action potential durations from the SMNs to maintain its synchrony.

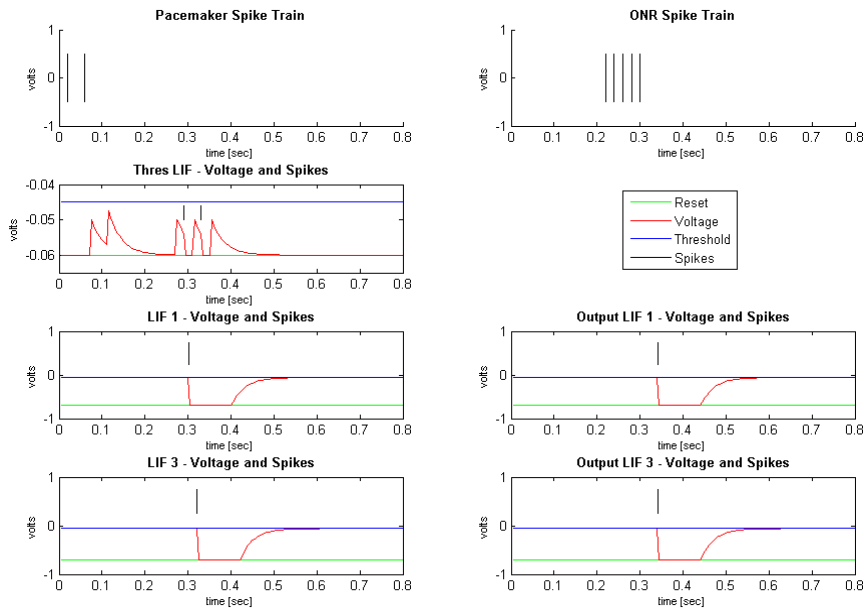

Figure 5.16: The two graphs at the top of the figure show the input spike train recordings for the Pacemaker and the ONR. The graph below shows that the Threshold neuron only fires if it receives enough stimulation. This stimulation is entirely from the ONR.

Therefore the hypothesis has been upheld. However the lack of literature regarding this system has been identified. The model only produces a possible solution to how the INR ring may actually operate in real life.

### Analysis of Results

The threshold LIF on this model will spike if sufficient stimulus is received. In the demos that were run it took a variety of inputs from both Input 1 (the ONR) and Input 2 (the pacemaker) for the Thres LIF to spike. The literature does not identify how much and what type of input is required for the Thres LIF to spike. The model assumes that the Thres LIF receives equal stimulation from both Input 1 (the ONR) and Input 2 (the pacemaker). There needs to be further investigation into how much Input 1 and Input 2 contribute to this neuron. These are all areas that would benefit from further biological research



### **Interesting/Problem areas**

There was no problem in connecting the two input spike trains to the threshold LIF and no perceived problems in connecting further inputs. However, gaining the required behaviour from the threshold LIF required modification to the weight property of the two input synapses (Input Syn1 and Input Syn 2). The modification resulted in spikes that had less of an effect to the Threshold LIF. Therefore the Threshold LIF required many spikes for it to fire.

### **Strengths and Weaknesses of Model**

The main weakness in this model is the assumption that the synchronous stimulation to the SMN rings works with a decaying action potential duration. This assumption was discussed in the previous chapter and was deemed appropriate for this model.

Similar to other models, the input has been restricted to a single neuron in the ring. Satterlie (2002, p.1659) comments:

”the output of the swim system is the same irrespective of which neuron is the initiator”

Obviously due to the inability to reproduce a decaying action potential, the hard coding has been put in place. If the input spike was to initiate a different neuron (e.g. LIF 2), the synchrony would not be maintained.

### **5.7.5 Future Work**

All future work is brought together and discussed in its entirety in sections 6.4 and 6.5.

## **5.8 General Conclusions**

The three jellyfish neural elements identified in the design stage (pacemaker, ring of SMNs and INR) have all been represented with a varying degree of accuracy. The output graphs have shown that the models produce realistic behaviour to that of a jellyfish. Setting the parameters for all of the models has proved to be a complex task, but especially so for the Thres LIF.

The development stage was very much a learning process. As each new neural element has been programmed, the knowledge gained from previous models has been applied.

Model 1 can be discounted for evaluation as Model 2 is a far superior model in terms of both realism and behaviour. Model 2 simulates a ring of SMNs. The ring takes input through one neuron and then all neurons within the ring fire in synchrony. Although CSIM was not able to model decaying action potential durations, this has been modelled with hard coded delays.

Model 3 simulates the pacemaker. The model outputs regular spikes by recycling the action potential between the network of neurons. The network can be switched on and off by excitatory and inhibitory spiking input neurons respectively.

Model 4 simulates the INR. The mechanism in respect of how the neurons within the ring fire synchronously, has been copied from the SMN mechanism. The threshold LIF is critical in this model and determines whether the input received is enough to make the whole ring spike.

Sections 3.4.3 and 3.4.4 identify various electrical properties that could have been used in the models. The list was gathered from the literature but was somewhat incomplete. It was therefore thought a better idea to use the complete set of default settings that CSIM provided. This meant the various CSIM elements would give us a predictable and standard behaviour. It was thought to be more important to model realistic behaviour than realistic electrical activity.

It could be argued that we have various swimming elements, but lack a complete system. The models were not integrated into a single system for several reasons. The underlying factor was that not enough project time was scheduled for development. Unfortunately the time it took to get CSIM up and running and become familiar with it was longer than estimated. A positive decision was taken to give more time to the analysis of the models that had been developed rather than integrating them into one. An integrated model would give the advantage of showing how the different models would interact. This would be an area that could be studied further.

The difficulty in fitting all the models together would have been apparent due to the alignment of different electrical properties. Throughout development it has been seen that these settings are very volatile and sensitive to change. The eventual model would have been cluttered with approximately sixty neural elements. Knowing what elements to record from and how to display the data in a meaningful output would have been a difficult process.

During the modelling of the pacemaker there was an initial problem in switching the unit off. This had little to do with the model and more to do with inexperience with inhibitory spikes. It was not realised that the timing of the inhibitory spike had to precede the excitatory spike by a small duration. The effect of inputting an inhibitory spike too early into the neuron was made void because the voltage had time to repolarise to the resting level.

There was a problem in using CSIM to model the decaying action potential found in both the SMNs and the INR. The solution was to hardwire such a system with synaptic delays. The results that were produced accurately showed

how the jellyfish behaves. However, the physical attributes of the model were inaccurate and caused limitations, such as only allowing input to the networks through a single neuron. Spencer (1995, p.523) confirms that modelling using hard coding is the wrong approach to take by stating:

”Hard wiring is not the solution for the hydromedusae since the motor action potential can initiate anywhere in the nerve ring (e.g. through photosensitivity), and hence conduction distance and conduction delay are unpredictable”.

Interestingly Spencer (1995, p.522) also states that in another jetting animal, the squid, synchronous contraction is achieved by hard wiring conduction delays. CSIM may be more appropriate for modelling such an animal.

None of the biological hypotheses have been invalidated. Instead they have shown the limitations of the computational models that have been created.

# Chapter 6

## Conclusion

### 6.1 Hypothesis

The hypothesis set at the beginning of this project was:

*Using available Spiking Neural Network Models a biologically plausible model of selected neurological behaviour of a jellyfish can be constructed.*

This project has shown that some aspects of jellyfish behaviour can be modelled using appropriate spiking neural network software. The models have accurately replicated the behaviour of the key subsystems within the jellyfish swimming system. The mimicked behaviours from these elements (such as constant output from the pacemaker and synchronous firing of a SMN ring) can be seen in the graphical output presented in Chapter 5. Although the jellyfish is known to be a relatively simple organism, in terms of neurology, the absolute complexity of modelling it is also recognised. This is why only a specific area of behaviour was focused on.

Some of the mechanisms within the jellyfish are specialised and, as a result, are not capable of being modelled by the components offered by the CSIM package. One such mechanism is the decaying action potential duration within the SMNs that is modelled via hard coded synapses. These specialised mechanisms were interpreted and re-designed so that they could still be included within the models. This meant that some models required bespoke code to implement their design. Nevertheless, they still provided the primitive design that was identified in the aims of the project.

## 6.2 Insights Shown by Simulation

As stated above, the jellyfish can be considered a relatively simple animal, but we are still unaware of the neural system as a whole. At the beginning of the project it was not appreciated how underdeveloped the field of spiking neural networks was, or that new findings were still changing the understanding of the biology of jellyfish. The simulated models identify how complicated it is to program even a simplified part of a jellyfish neural system.

Models that replicate the behaviour of the swimming motor neurons, inner nerve ring and pacemaker have all been produced from scratch. All the models possess different behaviour attributes: synchronous spiking from a ring of neurons, a threshold neuron that fires on only sufficient timed input (i.e. more than one spike in the time it takes one spike to return to its resting voltage) and a system that produces regular output spikes. The three behaviours are very different and it is surprising that such activities could be created with spiking neural networks.

The models are not always realistic in terms of their physiology. For example the model of the SMN ring only contains four neurons and in reality it is thought to have more than this. The physiological differences can be disregarded for this purpose because the various behaviours have all been modelled conceptually and, if needed, the same modelling techniques could be applied to a greater number of neurons without producing a different result.

Electrical properties for various neural systems have been highlighted in previous chapters. For example, in section 3.4.3 the resting potential voltage of the inner nerve ring is specified as -55 to -65 mV. During the modelling it was realised the neurons were particularly sensitive to changes in their parameters. Therefore modelling accurate electrical properties on a future model would require a full set of defined settings. Areas similar to this, in which further research needs to be conducted, are reviewed in section 6.4.

## 6.3 CSIM

Although some features of the neural systems had to be modelled in a primitive way, CSIM has proved successful for the initial modelling that was required. It was a challenge to obtain the required behaviour from the networks, but this was due to the difficulties of designing a spiking neural network rather than any direct problems with the package.

After the initial problems of setting up CSIM, the package was fairly simple to use. Complex neural elements, such as neurons and synapses, were easy to create through an object-orientated design. The syntax was compact and clear to understand. The documentation proved to be concise and was easily referred to throughout development.

The developments made use of three neural elements. The CSIM package has more than fifty neural element varieties that offer specially modelled neurons and synapses. Specifically the ‘KChannel Korngreen02’ and the ‘CaChannel Yamada98’ objects may relate to the K+ and C++ currents that Spencer (1995, p.520) identifies.

The speed of the CSIM package was advantageous. It took no more than a couple of seconds for CSIM to interpret the code, simulate the data and output the graphs. Immediate results were viewable, which made it easy to make alterations to the models and use an iterative development technique. Some models used over thirty neural elements, although the CSIM manual claims it should be capable of modelling networks far larger than this.

The CSIM package provides typical features associated with spiking neural networks. Unfortunately not all neural systems within jellyfish are typical. Carnell (2005) confirms that action potentials within CSIM are not modelled in a typical way (see figure 5.2). In CSIM a spike is fired from the neuron as soon as soon the voltage level reaches the threshold. There is no depolarisation or action potential and the neuron immediately enters the repolarisation stage. This made it impossible to model the decaying action potential duration that was needed for the SMN rings.

CSIM 1.0 is very much in the early stages of development. The CSIM manual (IGI 2004, p.15) states that a multi-threaded version of CSIM is currently under development. Such a feature would have allowed the three neural systems (SMN rings, INR and pacemaker) rings to be integrated more easily.

In conclusion CSIM is a free package that can model neural networks efficiently and is effective for the purposes of this project. Stretching the functionality of the package to model a decaying action potential duration in an artificial way may result in other restrictions, such as only allowing input through a single neuron. Perhaps a more advanced package would be required for more complex simulations.

CSIM offers a programmable interface that is easy to use, consistent and powerful. However, it has limitations and for this project the inability to model the decaying action potential duration is particularly significant. To overcome these:

- Either CSIM gets amended by the developer of the package. As the version used was the first one to be released, this seems possible.
- Or CSIM (as its open source) could be developed by the researcher himself.

We can, therefore, conclude that CSIM has been an appropriate choice of spiking neural networking software for this project.

## 6.4 Contributions to Field

This section summarises the contributions that have been made to both the Computer Science and jellyfish biology fields.

Prior to this project it was not known whether jellyfish behaviour could be simulated by neural networking software. It has been shown that realistic behaviour can be reproduced in an artificial way. The primitive models offer an introductory point for a further scientific investigation.

Model 1 and 2 suggested two possible solutions to prevent the continual firing of the ring: a refractory period on the neuron or synaptic weightings that decay the signal. The models would indicate that the former provides a more likely explanation for the phenomenon.

The literature confirms the decaying action potential duration mechanism in the SMNs. Unfortunately the literature offers no explanation to how the synchrony is maintained within the INR and in Model 4 we have hypothesised that it uses a similar mechanism to that in the SMNs. The modelling of the INR was dependent on this assumption, and this is an assumption that needs further biological investigation.

The INR was modelled with equal input contributions from the ONR and pacemaker systems. The literature did not include details of whether this should be split in a more accurate ratio. This is an area that could be the subject of further investigation.

Little was known about the pacemaker system that was developed in Model 3. The literature constantly referred to the system but did not acknowledge the mechanics behind it, how many of them there were or where they were located. Model 3 is a possible solution to how the pacemaker property may exist within the INR. We also conclude that the pacemaker cannot continue outputting action potentials indefinitely because it is impossible for a system to maintain 100% of its energy. Therefore we concluded that the pacemaker must have a compensatory mechanism that recognises when the system is low on energy and this is again an area that requires further biological investigation.

The project has highlighted several points of jellyfish biology that are unknown, or not made clear in the literature. The following list identifies what knowledge is missing from the neural swimming systems of a jellyfish:

- Information regarding the pacemaker - how the mechanism functions, how the unit switches on and off, where it is located, whether there is more than one pacemaker, how the low energy mechanism works (described above)
- Complete electrical properties for each system
- How the INR and SMN rings connect

- How the INR delays the action potential to the four SMN rings
- How the decaying action potential duration changes as the jellyfish grows in size
- Details of how the SMN rings connect at the apex
- Whether a refractory period mechanism in the SMNs could be used to modulate the maximum number of muscle contractions per second

## 6.5 Further Work for Computer Scientists

The groundwork of this project presents a unique opportunity for further research and significant progression in a new and exciting field. The literature concerning jellyfish locomotion has been collated and explained using terms that a computer scientist would understand. The simulation models that have been produced give an idea of what sort of results are feasible. Several areas for further investigation could be undertaken and what follows is a selection of the more interesting options.

One of the most interesting areas, that has a range of literature backing it up, is the decaying action potential duration found in the swimming motor neurons. It has been identified that such a mechanism is not achievable in CSIM. To model the mechanism would require either a significant amendment to the CSIM package or a different package altogether. The advantages of including the mechanism would mean that any neuron could be initially stimulated and the synchronous firing would still occur. This would allow the photosensitivity property of the SMNs to be modelled. From here, the natural route to follow would be studying the connection of the four rings at the apex of the jellyfish bell, although the research direction is less clear.

Spencer (1995, 520) highlights the complexities of the mechanics behind the SMNs. Two essential membrane currents (a fast, transient  $K^+$  current; and a transient  $Ca^{++}$  current) are recognised to be present. As stated in section 6.3 such modelling may be possible using some of the standard CSIM classes. It is likely that the person undertaking the research would need cross-subject field cooperation from a neurologist to decode some information within the paper.

The one notable omission from this project was an integrated model that represented the whole jellyfish swimming system (the reasons for omission are in section 5.8. It would be a valuable study to see how the various neural systems operated and interacted side by side, though we believe that the parts could be integrated in a straightforward manner.

This section has described just a selection of the many investigations that could be followed. The possibility of studying other parts of the jellyfish (such as the ONR or the sensory neurons) or even a different jellyfish type (such as the *Aglantha Digitale*) have not even been discussed. Jellyfish biology as a research



field is fairly active at present and hopefully some of the holes within the current level of understanding will be filled. Any such information could be used to make progress with the modelling of a jellyfish.

## 6.6 Personal Reflections

On the whole, the project has been very successful. To the best of our knowledge, the use of spiking neural network software to model a living organism had not previously been tried. The models have produced some realistic behaviour, although there is still clearly room for improvement.

The two fields of neurology and jellyfish biology are vast, complex and, prior to this project, had not been studied by the author. The task of drawing together ideas from these two fields has involved a large amount of background reading in order to gain sufficient understanding. It has been necessary to acquire the skill of extracting relevant material, whilst recognising parts that were beyond the scope of the project. One of the main achievements in the project has been collating all the literature to form a clear and complete account of the jellyfish neural swimming elements. Effort was made to review all possible information sources, even extending to personal communication with Spencer (2005). We were fortunate to have direct personal communication expertise for both spiking neural networks (Alwyn Barry, Daniel Richardson and Andrew Carnell, University of Bath) and jellyfish (William Megill, Bath University). At points it may have proved useful to have access to a neurologist and biologist.

It was known the project was concerned with preliminary research, but we were unsure what level of modelling would be possible. This uncertainty is also apparent through the discoveries being made within the jellyfish and spiking neural network fields. Lin et al.'s (2001) recent findings regarding the contiguity of the SMN network around each muscle sheet were a key part of one of our models.

The use of the Scientific Method (section 1.3) was critical in the development of the four models. Breaking down the development gave the scope and focus to deal with the task at hand. Ironically, studying the Scientific Method made it appear quite complex, but putting it into practice seemed very natural and even appropriate for everyday problem-solving.

The Gantt chart planning was a sensible part of the project. It provided a useful time plan, allowed us to monitor our progress and gave a high level view of the tasks that needed to be completed.

In hindsight, more time probably should have been scheduled for development. It was not recognised that development time would be hindered by the problems of getting CSIM up and running. We were conscious not to extend the development period so that other parts of the project were compromised. This time constraint prevented a more thorough exploration of some ideas, in particular

the integration of the four models to form a single system, but it still allowed us to perform a complete analysis of the models that had been produced.

The creation of the Gantt chart in Microsoft Visio was somewhat limiting. Updates to the chart, such as moving or adding tasks, were tedious to implement. A different tool aimed specifically at project management might have encouraged us to update and use the chart in the standard way. Nevertheless, the Gantt chart helped us manage our time. An instance of this was the decision to stop coding four weeks before the project was due.

Referencing the original aims and objectives set in section 1.2, we have:

- Completed a literature review that has identified the main parts of the jellyfish neural structure
- Determined the current levels of understanding within the jellyfish field
- Designed a primitive model for parts of the jellyfish's neural swimming system
- Successfully elicited realistic requirements for the jellyfish neural systems
- Produced a report on the spiking neural network software available
- Programmed within CSIM to produce neural models that display realistic behaviour

In this project I have learnt:

- How to produce a project plan
- How to read highly complex material in a subject area that was totally new to me and very different from Computer Science
- How to conduct a comprehensive literature review
- How to direct research where the final outcome was unclear at the beginning
- About different types of neural networks, especially spiking neural networks
- History of the neural network field
- The history and details of jellyfish biology
- How to use the Scientific Method for research
- About the availability and quality of neural network packages generally
- How to produce hypotheses to test by experiment
- How to use Matlab and produce graphical output

- How to install and run CSIM
- How to develop in CSIM
- How to monitor progress against the project plan and make appropriate changes to the schedule as needed
- How to use the  $\text{\LaTeX}$  type setting package
- How to use the Harvard reference style
- How to interact with senior academic figures successfully
- How to collate material to produce a simplified model that has not appeared in the literature before
- How to produce original research that makes contributions to the field

The project has been a significant learning experience and has involved the application of a number of key skills acquired during the degree course. Such skills include time management, project planning, research, programming, scientific analysis and written communication. The project has been interesting and enjoyable. Much has been achieved in a relatively short space of time and it is rewarding to have made a significant contribution towards two active areas. It is hoped the project will stimulate further investigations from biologists and computer scientists alike.

# Bibliography

- Biology Daily (2005), 'Jellyfish', [online].  
\*Available From: <http://www.biologydaily.com/biology/Jellyfish>  
[Accessed 14 April 2005]
- Carlson, J. (1999), 'Are jellyfishes dumb? (because of no brain)', [online].  
\*Available From: <http://www.madsci.org/posts/archives/sep99/936758726.Gb.r.html> [Accessed 24 November 2004]
- Carnell, A. (2005), 'Personal Communication - Meeting in the Computer Science Postgraduate Laboratory, University of Bath, UK'. 1 March 2005. Attended by - Mark Brooks, James Yeomans and Andrew Carnell.
- Hennessy, J. (2000), 'Neural Networks', [online].  
\*Available From: <http://www-cse.stanford.edu/classes/sophomore-college/projects-00/neural-networks/History/index.html> [Accessed 24 November 2004]
- IGI (2004), *CSIM : A Neural Circuit SIMulator - Version 1.0 - User Manual*. Available From: <http://www.lsm.tugraz.at/csim/usermanual/index.html> [Accessed 5 April 2005].
- Kandel, E. R., Schwartz, J. H. & Jessell, T. M., eds (1991), *Principles of Neural Science*, 3 edn, Appleton & Lange, Connecticut, USA.
- Kellan, A. (1996), 'Jellyfish: millions of years of stinging success', [online].  
\*Available From: <http://www.cnn.com/EARTH/9607/29/jellyfish/> [Accessed 24 November 2004]
- Lin, J. Y. C., Gallin, W. J. & Spencer, A. N. (2001), 'The anatomy of the nervous system of the hydrozoan jellyfish, *Polyorchis penicillatus*, as revealed by a monoclonal antibody', *Journal of Invertebrate Neuroscience* **4**, 65–75.
- Maass, W. & Bishop, C. M., eds (2001), *Pulsed Neural Networks*, MIT Press, Massachusetts, USA.
- Mackie, G. O. & Meech, R. W. (1995), 'Central Circuitry In The Jellyfish *Aglantha Digitale* - II The Ring Giant and Carrier Systems', *Journal of Experimental Biology* **198**, 2271–2278.
- McCulloch, W. S. & Pitts, W. (1943), 'A Logical Calculus of Ideas Immanent in Nervous Activity', *Bulletin of Mathematical Biophysics* **5**, 115–133.

- Megill, W. M. (1991), 'The biomechanics of jellyfish swimming'. PhD thesis, University of British Columbia, Canada.
- Megill, W. M. (2005), 'Personal Communication - Meeting at the Senior Common Rooms, University of Bath, UK'. 22 March 2005. Attended by - Mark Brooks, Alwyn Barry (Project Supervisor) and William Megill.
- Minsky, M. & Papert, S. (1969), *Perceptrons, An introduction to computational geometry*, MIT Press, Massachusetts, USA.
- Natschlager, T. (1998), 'Networks of spiking neurons - A new generation of neural network models', [online].  
 \*Available From: [http://www.igi.tugraz.at/tnatschl/online/3rd\\_gen\\_eng/3rd\\_gen\\_eng.html](http://www.igi.tugraz.at/tnatschl/online/3rd_gen_eng/3rd_gen_eng.html) [Accessed 24 November 2004]
- O'Dwyer, C. T. (2004), 'Development and observations of a symbolic internal state neuron'. Dissertation (BSc(Hons)). Computer Science Department, University of Bath, UK.
- Olmsted, D. (1998), 'History and Principles of Neural Networks to 1960', [online].  
 \*Available From: [http://www.neurocomputing.org/History/body\\_history.html](http://www.neurocomputing.org/History/body_history.html) [Accessed 24 November 2004]
- Preece, J., Rogers, Y. & Sharp, H. (2002), *Interaction Design: Beyond Human-Computer Interaction*, John Wiley and Sons, New York, USA.
- Princeton Cognitive Science Laboratory (2005), 'WordNet 2.0 Search', [online].  
 \*Available From: <http://www.cogsci.princeton.edu/cgi-bin/webwn?stage=1> [Accessed 12 May 2005]
- Public Broadcasting Service (2005), 'Cardiac pacemaker', [online].  
 \*Available From: <http://www.pbs.org/wnet/brain/history/> [Accessed 10 May 2005]
- Russell, S. J. & Norvig, P. (1994), *Artificial Intelligence: A Modern Approach*, Prentice Hall, New Jersey, USA.
- Satterlie, R. A. (2002), 'Neuronal control of swimming in jellyfish: a comparative story', *Canadian Journal of Zoology* **80**, 1654–1669.
- Satterlie, R. A. & Spencer, A. N. (1983), 'Neuronal Control of Locomotion in Hydrozoan Medusae', *Journal of Comparative Physiology* **150**, 195–206.
- Smith, L. (1996), 'An Introduction to Neural Networks', [online].  
 \*Available From: <http://www.cs.stir.ac.uk/~lss/NNIntro/InvSlides.html> [Accessed 24 November 2004]
- Spencer, A. N. (1978), 'Neurobiology of Polyorchis. I. Function of Effector Systems', *Journal of Neurobiology* **9**(2), 143–157.
- Spencer, A. N. (1979), 'Neurobiology of Polyorchis. II. Structure of Effector Systems', *Journal of Neurobiology* **10**(2), 95–117.

- Spencer, A. N. (1981), 'The Parameters and Properties of a Group of Electrically Coupled Neurons in the Central Nervous System of a Hydrozoan Jellyfish', *Journal of Experimental Biology* **93**, 33–50.
- Spencer, A. N. (1982), 'The Physiology of a Coelenterate Neuromuscular Synapse', *Journal of Comparative Physiology* **148**, 353–363.
- Spencer, A. N. (1995), 'Modulatory Mechanisms at a Primitive Neuromuscular Synapse: Membrane Currents, Transmitter Release and Modulation by Transmitters in a Cnidarian Motor Neuron', *American Journal of Zoology* **35**, 520–528.
- Spencer, A. N. (2005), 'Jellyfish swimming.'. 14 April. Email from Andy.Spencer@shaw.ca. Email to M. Brooks (cs1mb@bath.ac.uk).
- Spencer, A. N. & Arkett, S. A. (1984), 'Radial Symmetry and the Organisation of Central Neurones in a Hydrozoan Jellyfish', *Journal of Experimental Biology* **110**, 69–90.
- Spencer, A. N. & Satterlie, R. A. (1980), 'Electrical and Dye Coupling in an Identified Group of Neurons in a Coelenterate', *Journal of Neurobiology* **11**, 13–19.
- Spencer, A. N. & Satterlie, R. A. (1981), 'The Action Potential and Contraction in Subumbrellar Swimming Muscle of *Polyorchis penicillatus* (Hydromedusae)', *Journal of Comparative Physiology* **150**, 195–206.
- Stergiou, C. & Siganos, D. (1996), 'Neural Networks - Appendix A - Historical background in detail', [online].  
 \*Available From: [http://www.doc.ic.ac.uk/~nd/surprise\\_96/journal/vol14/cs11/report.html](http://www.doc.ic.ac.uk/~nd/surprise_96/journal/vol14/cs11/report.html) [Accessed 24 November 2004]
- Wikipedia (2005a), 'Action potential', [online].  
 \*Available From: [http://en.wikipedia.org/wiki/Action\\_potential](http://en.wikipedia.org/wiki/Action_potential) [Accessed 12 May 2005]
- Wikipedia (2005b), 'Cardiac pacemaker', [online].  
 \*Available From: [http://en.wikipedia.org/wiki/Cardiac\\_pacemaker](http://en.wikipedia.org/wiki/Cardiac_pacemaker) [Accessed 24 November 2004]
- Wolfs, F. (2005), 'Introduction to the Scientific Method', [online].  
 \*Available From: [http://teacher.nsr1.rochester.edu/phy\\_labs/AppendixE/AppendixE.html](http://teacher.nsr1.rochester.edu/phy_labs/AppendixE/AppendixE.html) [Accessed 05 May 2005]

# Appendix A

## Glossary

ANN - Artificial Neural Network

AP - Action Potential

Cm - Membrane Capacity

INR - Inner Nerve Ring

LIF - Leaky-Integrate-and-Fire (neuron)

NN - Neural Network

ONR - Outer Nerve Ring

PNN - Pulsing Neural Network

Polyorchis - Polyorchis Penicillatus

PSR - Post Synaptic Response

Rm - Membrane Resistance

SCM - Subumbrellar Circular Muscle

SMN - Swimming Motor Neuron

SNN - Spiking Neural Network

Syn - Synapse

Trefrac - Time of Refractory

VC - Velum Canal

Vinit - Initialisation Voltage

Vm - Membrane Voltage

Vreset - Reset Voltage

Vresting - Resting Voltage

Vthres - Threshold Voltage



## Appendix B

# Gantt Chart

Gantt Chart here

# Appendix C

## CSIM

### C.1 Errors in csim-1.0.zip

While installing and using CSIM (Windows version), two faults were found in the zipped package (csim-1.0.zip). The faults are listed below:

1. The directory ‘../lsm/csim/’ contains a mexglx file rather than a dll file. Download the dll file manually (csim-1.0.dll.zip). Delete the mexglx file and put the new dll file in its place.
2. The syntax for the demo ‘hh\_channels.m’ is incorrect in a minor detail. Line number 100 is:

```
csim('set','randSeed',randseed); % the randSeed
```

The variable randseed has not been defined. Either define it or replace the line with the following syntax:

```
csim('set','randSeed',123456); % the randSeed
```

### C.2 Running CSIM on the University of Bath Campus Network

The following is instructions for installing CSIM on the *Bath University Computer Services Network* (BUCS):

1. Download csim-1.0.zip and csim-1.0.dll.zip from <http://www.lsm.tugraz.at/download/index.html>. Unzip the packages and store in a folder contained in the local users space, e.g. ‘H:/CSIM’.

2. Follow the alterations in the above section to correct the package.
3. Open Matlab and add the 'lsm' directory (e.g. H:/CSIM/lsm) to the Matlab search path (By going to: File — Set path — Add folders with subfolders).
4. Save the path locally (BUCS network will not allow you to save it over the standard path).
5. Open 'first\_model.m' from the 'demos' directory, e.g. H:/CSIM/lsm/csim/demos. Press F5 and the demo should run and produce some graphical output.

# Appendix D

## The Code

### D.1 Model 1 - A ring of Swimming Motor Neurons

page 1

page 2

## D.2 Model 2 - A ring of Swimming Motor Neurons (Improved)



page 1

page 2

### **D.3 Model 3 - A Pacemaker**

page 1

page 2

## D.4 Model 4 - Inner Nerve Ring

page 1

page 2